

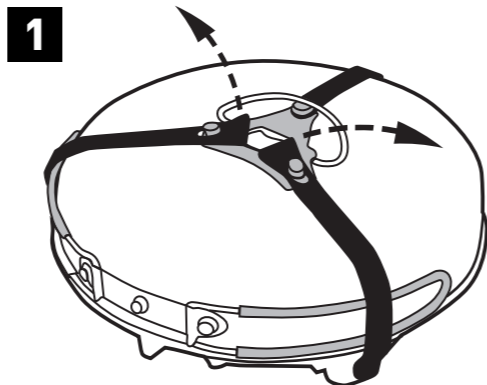

HALFGEN BASECAMP SYSTEM USER GUIDE

⚠ WARNING: For reference only.
Do not use product without first reading
included Instructions.

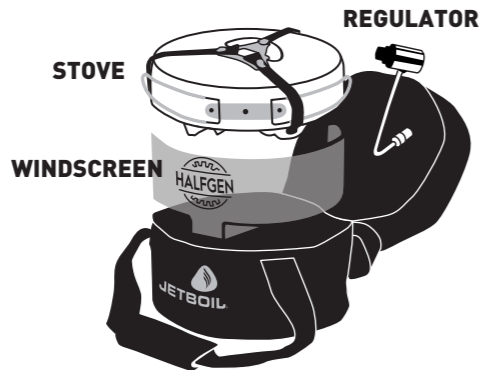

**UNDO RUBBER LATCHES
TO REMOVE PAN**

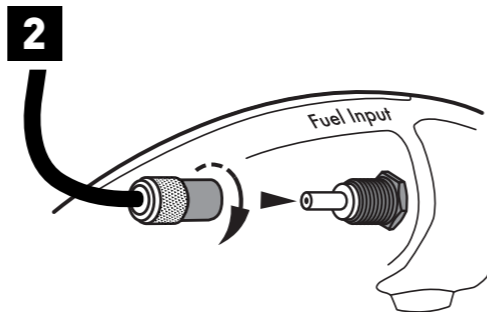

**CONNECT AND SECURE
REGULATOR TO FUEL
INPUT PORT
(REAR LEFT)**

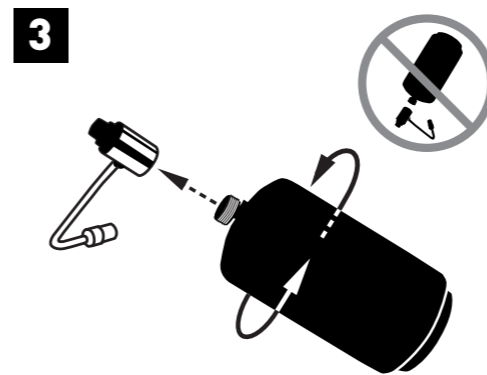

**CONNECT AND SECURE FUEL
CYLINDER TO REGULATOR
IN UPRIGHT POSITION**

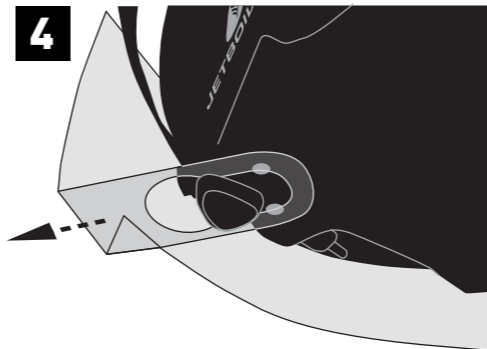

**ALIGN OPENING IN
WINDSCREEN TABS
OVER FEET AND
PULL TO LOCK**

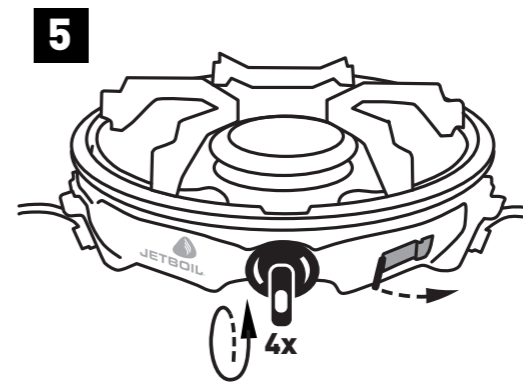

**OPEN VALVE FULLY
COUNTER CLOCKWISE
AND FLIP IGNITER LEVER**

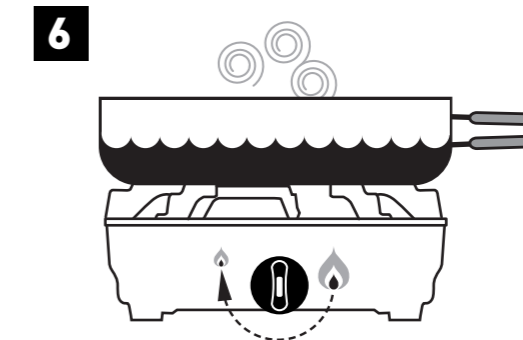

**ADJUST FLAME AS NEEDED
AND ENJOY!**



Welcome to JetHead Nation.

To the epic adventures in the world
and those who pursue them,
we salute you!

If you are not satisfied with this Jetboil product,
contact Customer Service at jetboil.com
or call 1-800-572-8822.



HALFGEN GUIDE DE L'UTILISATEUR DU SYSTÈME BASECAMP



Visualiser
une vidéo

⚠ Avertissement : À titre de référence seulement. Ne pas utiliser le produit sans avoir d'abord lu les instructions incluses.

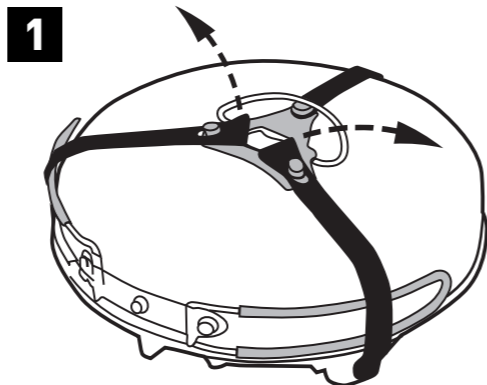
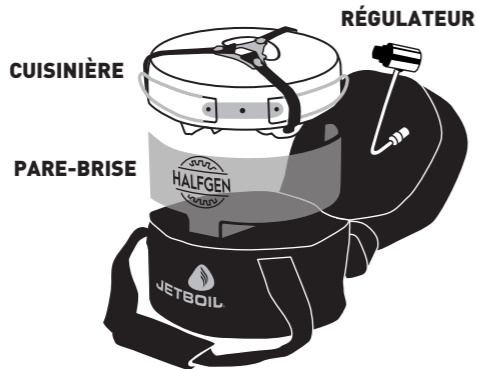

1
DÉFAIRE LES LOQUETS
EN CAOUTCHOUC POUR RETIRER
LE PLATEAU

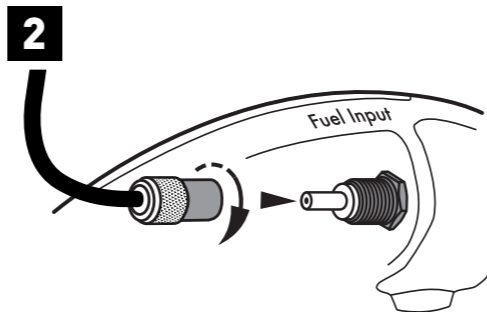

2
CONNECTER ET FIXER
LE RÉGULATEUR À L'ORIFICE
D'ENTRÉE DU CARBURANT.
(CUISINIÈRE ARRIÈRE GAUCHE)

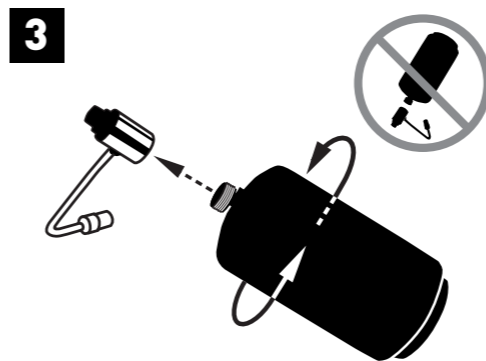

3
CONNECTER ET FIXER
LA BOUTEILLE DE CARBURANT
AU RÉGULATEUR
EN POSITION VERTICALE.

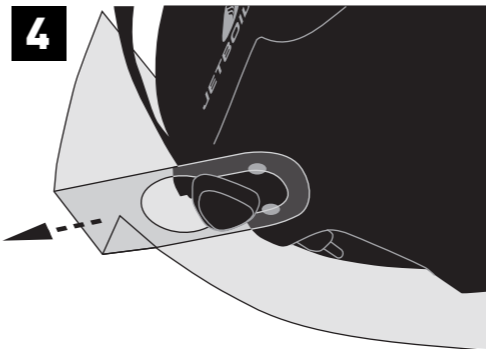

4
ALIGNER L'OUVERTURE DES
LANGUETTES DE L'ÉCRAN
ANTI-VENT SUR LES PIEDS ET
TIREZ POUR VERROUILLER

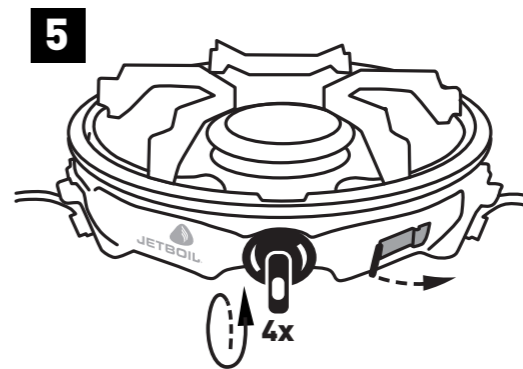

5
OUVRIR LA VANNE DE LA BOUTEILLE
DE CARBURANT COMPLÈTEMENT
DANS LE SENS ANTIHORAIRE ET FAIRE
BASCULER LE LEVIER DE L'ALLUMEUR.

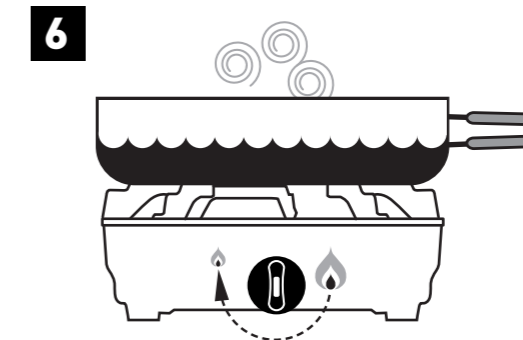

6
AJUSTER LA FLAMME
AU BESOIN ET SAVOURER!



Bienvenue dans la nation Jethead.

Nous saluons tous les aventuriers
dans le monde à la recherche
d'épopées fabuleuses!

Si vous n'êtes pas satisfait de ce produit Jetboil,
communiquez avec le service à la clientèle
au jetboil.com ou composez le 1-800-572-8822.