



Xpress IH Installation and Set-Up Instructions

PARTS LIST

Item #	Qty	Description
1	1	Trailer
2	1	Axle
3	1	Universal Pivot
4	1	Tongue
5	1	Tongue Bracket
6	1	Tipper Latch
7	1	Coupler, 2" Ball, 1.5 x 2 Tube
8	2	Wheel
9	2	Castle Nut
10	2	Cotter Pin
11	4	7/16 x 1 Bolt
12	4	7/16 Lock Washer
13	2	7/16 x 3 1/4 Bolt
14	2	7/16 Nylon Lock Nut
15	2	3/8 x 1 Bolt
16	6	3/8 Nylon Lock Nut
17	3	3/8 x 2 1/2 Bolt
18	1	3/8 x 3 1/4 Bolt
19	4	7/16 Washer
20	2	3/8 Washer

Tools Required:

Adjustable Crescent Wrench
9/16 Socket and Ratchet
5/8 Socket and Ratchet
3/8 Bit
Drill

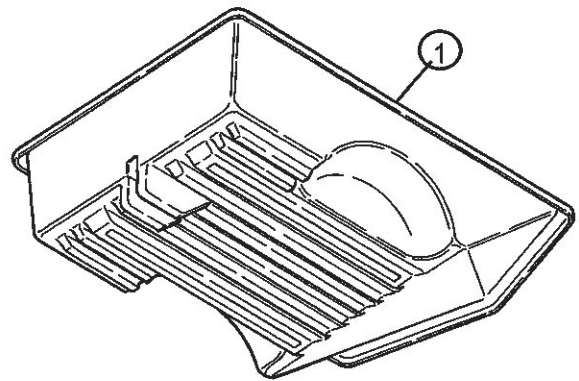

90152

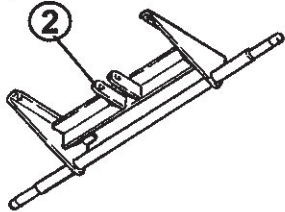

90177



90180

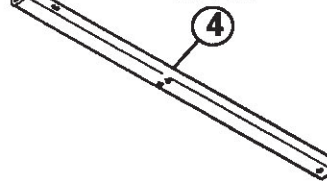

90165



80120



90159

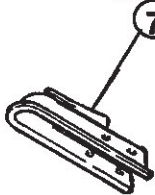

90172

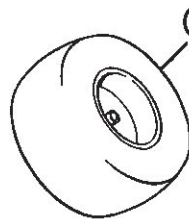

80132



10



11

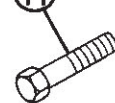

12



80313 (Parts 10-20)

13

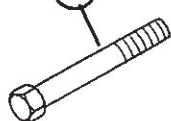

14



15



16



17

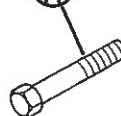

18

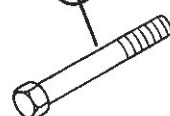

19



20

