



ROD HOLDER & DOWNRIGGER TROLLING SYSTEM



Rod Holders:

- Angled Fixed Mount 1907000
- Adjustable Single Axis 1907001
- Adjustable Rail Mount 1907020
- Adjustable Clamp Mount 1907021
- Adjustable Dual Axis 1907002
- Adjustable Downrigger Mount 1907024



CAUTION:
READ THIS MANUAL CAREFULLY
BEFORE OPERATING YOUR
NEW CANNON ACCESSORY.
RETAIN FOR FUTURE REFERENCE.

NOTE: Do not return your CANNON accessory to your retailer. Your retailer is not authorized to repair or replace this unit. You may obtain service by:

- calling CANNON at 1-800-227-6433;
- returning your accessory to the Factory Service Center; 121 Power Drive, Mankato, MN 56001

Please include proof of purchase and purchase date for warranty service with any of the above options.

Adjustable Dual Axis Rod Holder Shown

Owner's Manual

Rod Holder Models & Features

1907000 Angled – Fixed Mount Rod Holder

The Angled - Fixed Mount Rod Holder is 10 inches in length and has a fixed 60° angle. Adjustments can be made side to side by forty five degrees using the adjustable thumb screws in conjunction with an aluminum track. Clear anodized aluminum is used for strength and corrosion resistance and a UV resistant cap protects the finish of the rod and reel. The Angled Rod Holder is compatible with Cannon track systems.



1907001 Adjustable – Single Axis Rod Holder

1907020 Adjustable – Rail Mount Rod Holder

1907021 Adjustable – Clamp Mount Rod Holder

The Adjustable – Single Axis Rod Holder is 10 inches in length and has 6 locking positions up and down. Pistol grip release provides quick one hand up and down angle adjustment while the ratcheting adjustment system allows you to pull the rod holder straight up for rod removal. Adjustments can be made side to side by forty five degrees using the adjustable thumb screws in conjunction with an aluminum track. Clear anodized aluminum is used for strength and corrosion resistance and a UV resistant cap protects the finish of the rod and reel. The Adjustable Rod Holder is compatible with Cannon, Bert's, and Traxstech track systems.

Also available pre assembled to 1 1/4 inch rail mount and Clamp Mount.



REELS SCHEMATIC

1907002 Adjustable – Dual Axis Rod Holder

The Adjustable – Dual Axis Rod Holder is 10 inches in length and has 6 locking positions up and down with 360° rotation. Pistol grip release provides quick one hand up and down angle adjustment with 360° rotation with the push of the release button. Ratcheting adjustment system allows you to pull the rod holder straight up for rod removal. Clear anodized aluminum is used for strength and corrosion resistance and a UV resistant cap protects the finish of the rod and reel. This Adjustable Rod Holder is compatible with Cannon, Bert's, and Traxstech track systems.



1907024 Adjustable – Downrigger Mount Rod Holder



1904015 Rail Mount 3/4" to 1-1/4" 1904016 Rail Mount 1-1/4" to 2"

Cannon Rail Mounts allow for the mounting of Cannon Single and Dual Axis Rod Holders to round or square rail. Two sizes are available for round and square tube styles. Components are made from clear anodized aluminum and stainless steel for strength and corrosion resistance.



1904020 Clamp Mount

Cannon Rail Mounts allow for the mounting of Cannon single and dual axis rod holders to any transom or allowable clamping edge. Clamp opens to two and a half inches and is made from clear anodized aluminum and stainless steel for strength and corrosion resistance.

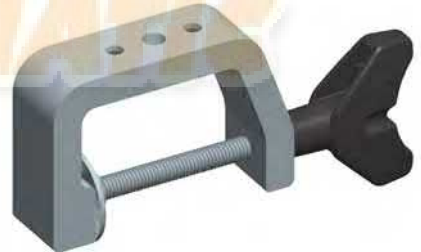

1904000 Deck Mount

The Cannon Deck Mount plate is a four inch by three inch clear anodized aluminum plate which allows the hard mounting of Cannon Dual Axis Rod Holders. The plate comes with a black protective mounting boot and all mounting hardware.



- 1904025 Aluminum Mounting Track 6"**
- 1904026 Aluminum Mounting Track 12"**
- 1904027 Aluminum Mounting Track 18"**
- 1904028 Aluminum Mounting Track 24"**
- 1904029 Aluminum Mounting Track 36"**

Cannon tracks allow for flexible mounting positions and easy removal of Cannon's track system accessories. Locking grooves allow thumb screws to index with track and prevent accessories from twisting. The system is compatible with Cannon, Bert's, and Traxtech track system products. Components are made from clear anodized aluminum and stainless steel for strength and corrosion resistance. All mounting hardware included. Available in 6, 12, 18, 24, and 36 inch lengths.



- 1904005 Pedestal Mount Track 12"**
- 1904006 Pedestal Mount Track 18"**

The pedestal mounting track is three inches high and allows for mounting of Cannon's track system accessories. Pedestal can be surface mounted or slid into mounting track for a variety of mounting positions and easy removal. The system is compatible with Cannon, Bert's, and Traxtech track system products. Components are made from clear anodized aluminum and stainless steel for strength and corrosion resistance. Mounting hardware is included. Pedestal is available in twelve and eighteen inch track lengths for mounting up to three track system rod holders.



- 1904010 Gimbal Mount Track – Side Gunned**
- 1904011 Gimbal Mount Track – Stern**

Cannon's Gimbal Mount Track allow for mounting of Cannon's track system accessories in flush mount rod holders. Thirty degree angled gimbals have twelve inch tube length with an outer diameter of 1-1/2 inches. Eighteen inches of track allow for mounting up to three track system rod holders. The system is compatible with Cannon, Bert's, and Traxtech track system products. Components are made from clear anodized aluminum and stainless steel for strength and corrosion resistance.

- 1904030 Fixed Base Downrigger Pedestal 4"**
- 1904031 Fixed Base Downrigger Pedestal 6"**

Cannon's fixed base downrigger pedestals can be surface mounted or track mounted for a variety of mounting positions and easy removal. The 3/4" thick aluminum top plate is pre-drilled and tapped for mounting Cannon downriggers as well as most Scotty®, Big Jon®, Penn®, Vector, Proos, Fishlander and Walker downriggers. Components are made from clear anodized aluminum and stainless steel for strength and corrosion resistance. The fixed base downrigger pedestals are compatible with Cannon, Bert's, and Traxtech track systems. Available in 4" and 6" heights.

CAUTION:
The Cannon Pedestal Mount is intended for use with a Track that is mounted directly to the deck of the boat ONLY.



1904032 Swivel Base Downrigger Pedestal 4” 1904033 Swivel Base Downrigger Pedestal 6”

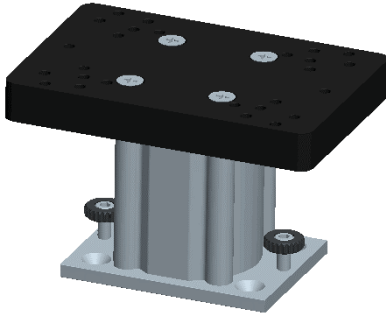

Cannon's swivel base downrigger pedestals can be surface mounted or track mounted for a variety of mounting positions and easy removal. With 16 locking points, these downrigger pedestals allow for 360° downrigger rotation with locking points every 22.5°. The 3/4” thick aluminum top plate is pre-drilled and tapped for mounting Cannon downriggers as well as most Scotty®, Big Jon®, Penn®, Vector, Proos, Fishlander and Walker downriggers. Bearing system ensures smooth swivel action even while a downrigger weight is attached. Components are made from clear anodized aluminum and stainless steel for strength and corrosion resistance. The swivel base downrigger pedestals are compatible with Cannon, Bert's, and Traxstech track systems. Available in 4” and 6” heights.

Rod Holder \ Accessory Compatibility

Mounts Rod Holder	Track Mount	Gimbal Track Mount	Pedestal Track Mount	Rail Mount	Clamp Mount	Deck Mount
Angled Fixed Mount	●	●	●	○	○	○
Adjustable Single Axis	●	●	●	●*	●*	○
Adjustable Dual Axis	●	●	●	●*	●*	●





● - Compatible ○ - Not Compatible * - Compatible with removal of track mount plate

Pedestal Mount \ Accessory Compatibility

Mounts Pedestal	Track Mount	Gimbal Track Mount	Pedestal Track Mount	Rail Mount	Clamp Mount	Deck Mount
4” Fixed Mount	●	○	○	○	○	●
6” Fixed Mount	●	○	○	○	○	●
4” Swivel Mount	●	○	○	○	○	●
6” Swivel Mount	●	○	○	○	○	●

● - Compatible ○ - Not Compatible

Replacement Parts

Part	Part Number	Description	USED ON
	3396562	END CAP	1904005, 1904006, 1904010, 1904018, 1904025, 1904026, 1904027, 1904028, 1904029
	3390210	VINYL CAP	1907000
	3393413	THUMB SCREW	1907000, 1907001, 1907002, 1904005, 1904006
	3391515	CAP ROD HOLDER	1907001, 1907002, 1907020, 1907021, 1907022, 1907023
	33986110	WEAR TIP	1907001, 1907002, 1907020, 1907021, 1907022, 1907023