

SPINNING REEL EMBLEM-X4500T/5000T

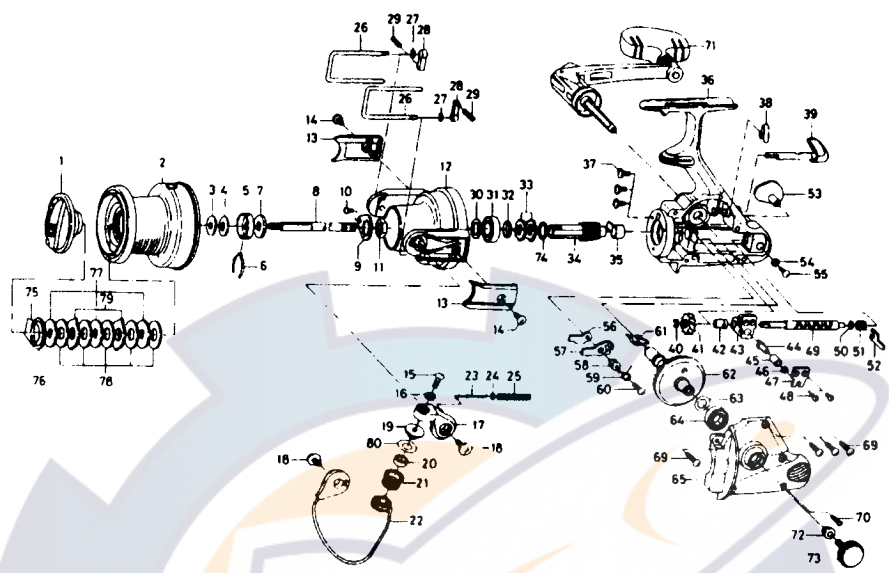

Key No.	Parts No.	Parts Name	Key No.	Parts No.	Parts Name
2,75-79	F52-7901	Spool assembly	49	E39-5201	Worm shaft
1	F52-8001	Drag knob	50	375-4102	Worm shaft washer
2	F52-9501	Spool assembly	51	E19-1101	Worm shaft collar
3	E39-9201	Spool washer A	52	F07-6901	Worm shaft retainer
4	F04-3401	Spool washer B	53	F30-0106	Rear cover
5	F20-4001	Click leaf spring holder	54	E15-3101	Rear cover washer
6	B74-7701	Spool click leaf spring	55	E33-0402	Rear cover screw
7	E26-7501	Main shaft washer	56	F39-0901	Anti-reverse pawl plate
8	F52-1202	Main shaft	57	F38-5201	Anti-reverse pawl
9	E33-3801	Rotor nut holding plate	58	E26-2101	Anti-reverse pawl collar
10	E15-7502	Rotor nut holding plate screw	59	E26-2201	Anti-reverse pawl spring A
11	B43-7605	Rotor nut	60	B83-5002	Anti-reverse pawl screw
12	F36-1109	Rotor	61	E26-4501	Anti-reverse pawl spring B
13	E39-6318	Bail spring cover	62	E39-5301	Drive gear
14	E10-7401	Bail spring cover screw	63	371-2822	Drive gear washer
15	E45-4004	Line roller screw	64	B54-6001	Ball bearing C
16	160-8401	Lock washer	65	F52-7801	Side cover
17	F47-2101	Bail arm	69	B00-9701	Side cover screw A
18	E00-7601	Bail arm screw	70	E15-8602	Side cover screw B
19	F44-6302	Line roller collar	71	F52-9401	Handle assembly
20	F05-5601	Ball bearing A	72	F40-9001	Handle collar
21	F45-4902	Line roller	73	L00-9107	Handle lock screw
22	F47-2201	Bail assembly	74	372-7603	Spacer
23	E32-6701	Bail spring shaft	75	170-4101	Drag washer retainer
24	E31-3901	Bail spring washer	76	F03-9701	Drag plate
25	E39-5901	Bail spring	77	F03-5101	Key washer
26	E39-6102	Line guard shaft	78	B36-0207	Drag washer
27	B33-9801	Line guard retainer	79	372-3832	Eared washer
28	E39-6201	Line guard plate	80	F44-6202	Line roller washer
29	F06-3301	Line guard spring			
30	372-7603	Bearing washer			
31	637-6101	Ball bearing B			
32	F03-5001	Spacing sleeve			
33	F04-3501	Anti-reverse ratchet			
34	E39-0202	Pinion gear			
35	E33-2101	Pinion collar			
36	F52-7701	Body assembly			
37	E03-7801	Bearing retainer screw			
38	E32-7801	Anti-reverse cam spring			
39	F03-5401	Anti-reverse lever			
40	320-5901	Worm shaft gear retainer			
41	F53-2701	Worm shaft gear			
42	E39-3501	Worm shaft bush			
43	E39-5101	Oscillating slider			
44	E26-4101	Oscillating pawl			
45	E26-4201	Oscillating pawl bush			
46	375-0801	Oscillating pawl washer			
47	F96-4301	Oscillating slider cover			
48	352-1502	Oscillating slider cover screw			

EM-X5000T Special parts

2,75-79	F53-2501	Spool assembly
2	F52-9601	Spool assembly
12	F36-1206	Rotor
22	F52-3601	Bail assembly
36	F52-8601	Body assembly
65	F52-8701	Side cover