

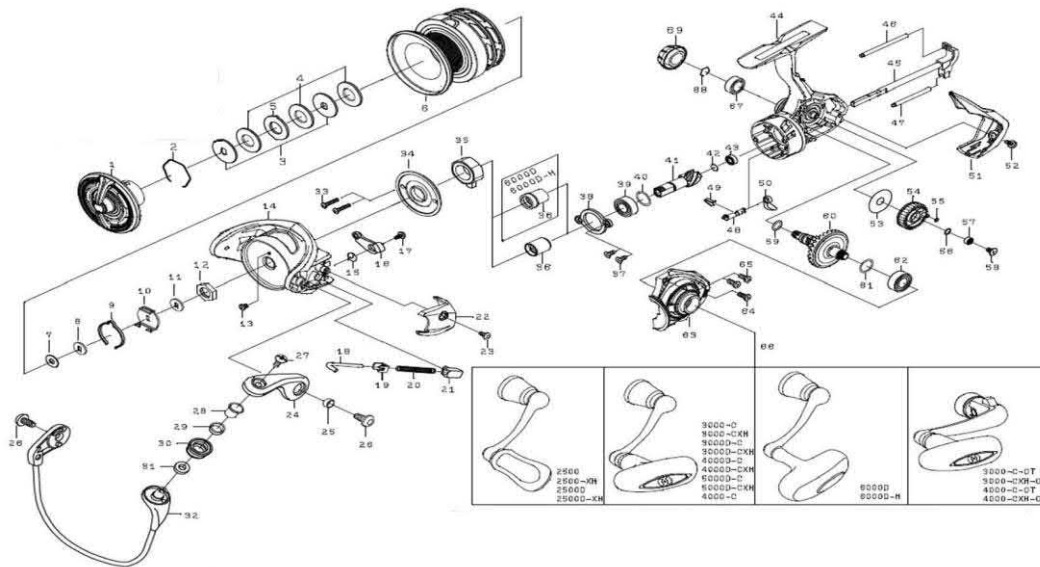

Please order by parts number, not key number
Veuillez indiquer le numéro de la pièce (Non "Key" No.)

SPINNING REEL EXLT2500D/2500D-XH/3000-4000D-C



Key No.	Part Name	EXLT2500D Part No.	EXLT2500D-XH Part No.	EXLT3000D-C Part No.	EXLT4000D-C Part No.
1	DRAG KNOB	Q34-6201	Q34-6201	Q34-6201	Q35-2901
2	DRAG RETAINER	Q34-6101	Q34-6101	Q34-6101	Q34-6101
3	DRAG DISC WASHER	J54-7001	J54-7001	J54-7001	J54-7001
4	ATD DRAG WASHER (3 PCS)	J67-8801	J67-8801	J67-8801	J67-8801
5	WASHER	Q34-6001	Q34-6001	Q34-6001	Q34-6001
6	SPOOL ASSEMBLY	Q38-7801	Q38-8201	Q38-9001	Q39-3001
7	SPOOL WASHER	E39-8003	E39-8003	E39-8003	E39-8003
8	SPOOL WASHER	Q34-8502	Q34-8502	Q34-8502	Q34-8502
9	CLICK LEAF SPRING	J52-5101	J52-5101	J52-5101	J52-5101
10	CLICK LEAF SPRING HOLDER	J54-6201	J54-6201	J54-6201	J54-6201
11	CLICK LEAF WASHER	Q34-4001	Q34-4001	Q34-4001	Q34-4001
12	ROTOR NUT	Q12-2401	Q12-2401	Q12-2401	Q12-2401
13	SCREW	H02-2701	H02-2701	H02-2701	H02-2701
14	ROTOR	Q34-3003	Q34-3003	Q12-0515	Q35-1803
15	BAIL TRIP LEVER SPRING	H41-3601	H41-3601	H41-3601	H41-3601
16	KICK LEVER	Q34-3101	Q34-3101	Q12-0701	Q35-1901
17	SCREW	H41-7701	H41-7701	H41-7701	H41-7701
18	ARM LEVER SHAFT	Q34-3301	Q34-3301	Q12-1201	Q12-9501
19	BAIL SPRING PLATE	H57-6101	H57-6101	H57-6101	H57-6101
20	BAIL LEVER SHAFT SPRING	J64-2801	J64-2801	H54-5701	H41-4201
21	BAIL SPRING HOLDER	Q12-1501	Q12-1501	Q12-1501	Q12-1501
22	ARM LEVER SPRING COVER	Q34-3501	Q34-3501	Q12-1801	Q35-2101
23	SCREW	Q34-2901	Q34-2901	Q34-2901	Q34-2901
24	BAIL ARM	Q12-1613	Q12-1613	Q12-1613	Q12-1613
25	COLLAR	Q12-1701	Q12-1701	Q12-1701	Q12-1701
26	BAIL ARM SCREW	Q34-3401	Q34-3401	Q34-3401	Q34-3401
27	SCREW	G19-5602	G19-5602	G19-5602	G19-5602
28	COLLAR	G19-5501	G19-5501	G19-5501	G19-5501
29	COLLAR	G22-0701	G22-0701	G22-0701	G22-0701
30	LINE ROLLER	J08-9901	J08-9901	J08-9901	J08-9901
31	COLLAR	Q20-3401	Q20-3401	Q20-3401	Q20-3401
32	BAIL ASSEMBLY	Q34-3601	Q34-3601	Q12-1901	Q35-2201
33	SCREW	G83-7101	G83-7101	G83-7101	G83-7101
34	SEALED PLATE	Q13-9401	Q13-9401	Q12-0101	Q12-9001
35	ROLLER CLUTCH	Q30-8301	Q30-8301	J38-8401	J38-8401
36	SPACING SLEEVE	J00-1401	J00-1401	J00-1403	J00-1403
37	SCREW	Q12-6201	Q12-6201	Q12-6201	Q12-6201
38	PINION BARING PLT	Q19-5601	Q19-5601	Q19-5601	Q19-5601
39	BALL BEARING	G46-7302	G46-7302	G46-7302	G53-5104
40	WASHER	375-8502	375-8502	375-8500	375-8502
41	PINION GEAR	Q34-1701	Q36-0301	Q34-1701	Q35-1201
42	SPRING WASHER	H93-1701	H93-1701	H93-1701	H93-1701
43	BALL BEARING	H95-9601	H95-9601	H95-9601	G46-6202
44	BODY	Q38-7601	Q38-7601	Q38-8901	Q39-2801
45	MAIN SHAFT	Q34-1501	Q34-1501	Q34-1501	Q35-1001
46	STABILIZER BAR	Q12-6301	Q12-6301	Q12-6301	Q12-6302
47	STABILIZER BAR	Q11-9101	Q11-9101	Q11-9101	Q11-9102
48	A/R CAM	Q11-8101	Q11-8101	Q11-8101	Q11-8101
49	A/R CAM SPRING	H69-7801	H69-7801	H69-7801	H69-7801
50	A/R LEVER	Q11-8001	Q11-8001	Q11-8001	Q11-8001
51	REAR COVER	Q34-2801	Q34-2801	Q34-2801	Q35-1701
52	SCREW	Q34-2901	Q34-2901	Q34-2901	Q34-2901
53	WASHER	H59-5701	H59-5701	H59-5701	H59-5701
54	OSC GEAR	Q13-9001	Q13-9001	Q11-8401	Q35-0901
55	O'RING	H77-0601	H77-0601	H77-0601	G46-6001
56	WASHER	H12-9201	H12-9201	H12-9201	H12-9201
57	BALL BEARING	G46-9005	G46-9005	G46-9005	G46-9005
58	SCREW	Q12-6101	Q12-6101	Q12-6101	Q12-6101
59	O'RING	G67-0501	G67-0501	G67-0501	G67-0501
60	DRIVE GEAR	Q34-1801	Q36-0401	Q34-1801	Q35-1301
61	WASHER	375-8502	375-8502	375-8500	375-8502
62	BALL BEARING	G46-7302	G46-7302	G46-7302	G46-7302
63	SIDE COVER	Q38-7701	Q38-7701	Q38-7701	Q39-2901
64	BODY COVER SCREW	Q34-2701	Q34-2701	Q34-2701	Q34-2701
65	BODY COVER SCREW	Q34-2601	Q34-2601	Q34-2601	Q34-2601
66	HANLDE ASSEMBLY	Q38-8001	Q38-8001	Q38-9801	Q39-3601
67	BALL BEARING	G52-2706	G52-2706	G52-2706	G52-2706
68	BEARING RETAINER	G47-2401	G47-2401	G47-2401	G47-2401
69	HANDLE CAP	Q34-5101	Q34-5101	Q34-5101	Q34-5101