

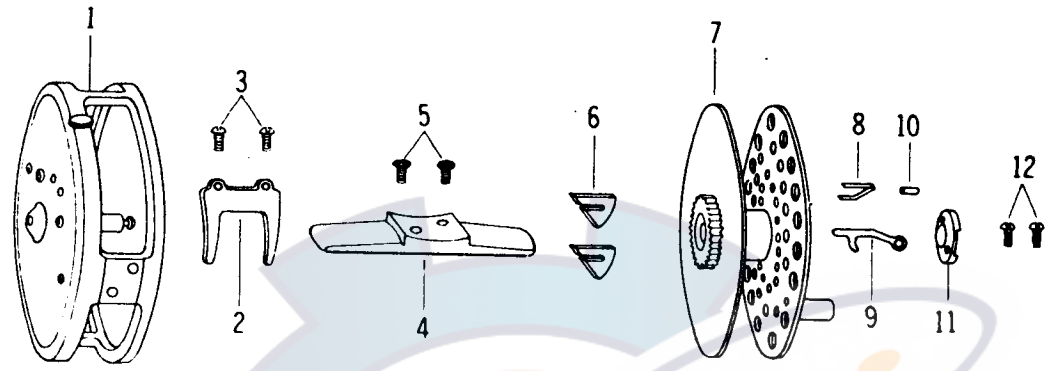

FLY REEL **740 720**  
**710 700**



**LINE CAPACITY: 30 LBS., No. 10 WT. FLY LINE**  
**Model 740**

Key No.	Parts No.	Parts Name	
1	6F740001	Body	
2	6F740002	Line guide	
3	6F700003	Line guide screw (2 pcs.)	
4	6F700004	Stand	
5	6F700005	Stand screw (2 pcs.)	
6	6F700006	Click (2 pcs.)	
7	6F740007	Spool	
8	6F700008	Stopper spring	Sold (6F740012)
9	6F700009	Spool stopper	as
10	6F700010	Stopper pin	One
11	6F700011	Stopper cover	Unit
12	6F700003	Stopper cover screw	

**LINE CAPACITY: 30 LBS., No. 9 WT. FLY LINE**  
**Model 720**

Key No.	Parts No.	Parts Name	
1	6F720001	Body	
2	6F700002	Line guide	
3	6F700003	Line guide screw (2 pcs.)	
4	6F700004	Stand	
5	6F700005	Stand screw (2 pcs.)	
6	6F700006	Click (2 pcs.)	
7	6F720007	Spool	
8	6F700008	Stopper spring	Sold (6F720012)
9	6F700009	Spool stopper	as
10	6F700010	Stopper pin	One
11	6F700011	Stopper cover	Unit
12	6F700003	Stopper cover screw	(2 pcs.)

**LINE CAPACITY: 30 LBS., No. 7 WT. FLY LINE**  
**Model 710**

Key No.	Parts No.	Parts Name	
1	6F710001	Body	
2	6F700002	Line guide	
3	6F700003	Line guide screw (2 pcs.)	
4	6F700004	Stand	
5	6F700005	Stand screw (2 pcs.)	
6	6F700006	Click (2 pcs.)	
7	6F710007	Spool	
8	6F700008	Stopper spring	Sold (6F710012)
9	6F700009	Spool stopper	as
10	6F700010	Stopper pin	One
11	6F700011	Stopper cover	Unit
12	6F700003	Stopper cover screw	(2 pcs.)

**LINE CAPACITY: 30 LBS., No. 6 WT. FLY LINE**  
**Model 700**

Key No.	Parts No.	Parts Name	
1	6F700001	Body	
2	6F700002	Line guide	
3	6F700003	Line guide screw (2 pcs.)	
4	6F700004	Stand	
5	6F700005	Stand screw (2 pcs.)	
6	6F700006	Click (2 pcs.)	
7	6F700007	Spool	
8	6F700008	Stopper spring	Sold (6F700012)
9	6F700009	Spool stopper	as
10	6F700010	Stopper pin	One
11	6F700011	Stopper cover	Unit
12	6F700003	Stopper cover screw	(2 pcs.)