

REGAL-X3500iA / 4000iA

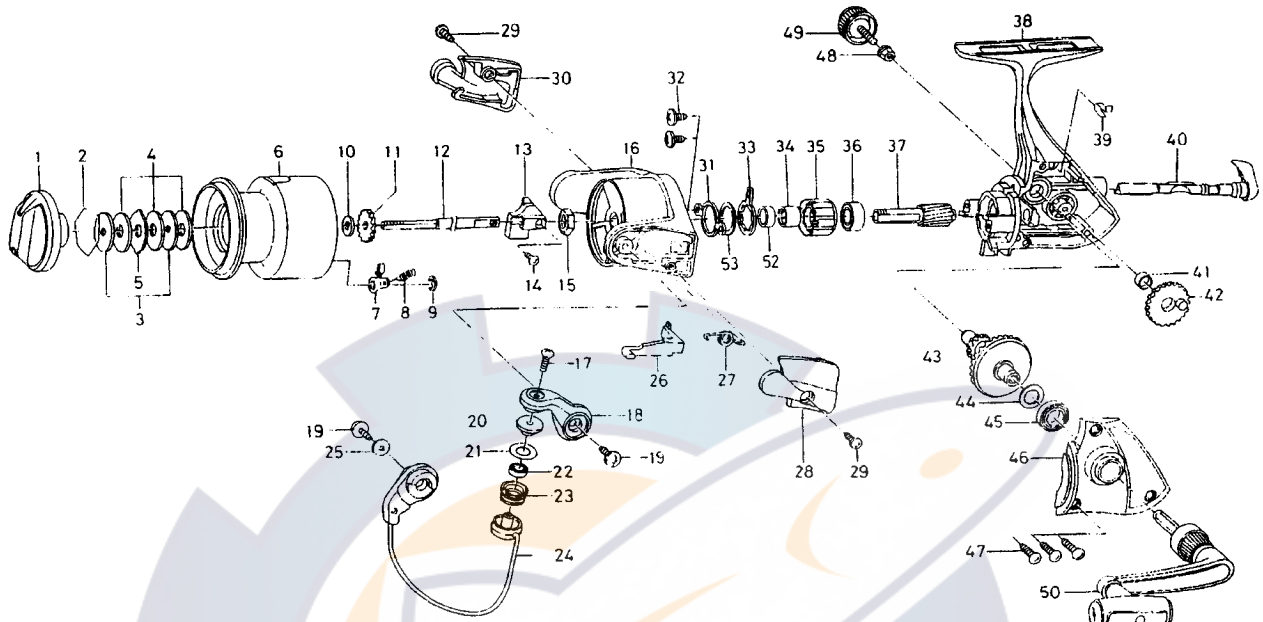

Key No.	Parts No.	Parts Name
2-9	F75-8301	SPOOL
1	F75-0102	DRAG KNOB
2	F37-3301	DRAG WASHER RET
3	F09-4901	KEY WASHER
4	E13-6001	DRAG WASHER
5	373-3603	EARED WASHER
7	B07-5304	CLICK PAWL
8	E40-3101	CLICK SPRING
9	320-5901	CLICK RET
10	F09-4701	SPOOL WASHER
11	E46-2701	CLICK GEAR
12	F74-8001	MAIN SHAFT
13	F74-7901	OSC SLIDER
14	352-1502	OSC SLIDER SCREW
15	340-6602	ROTOR NUT
16	F41-6110	ROTOR
17	F67-7901	LINE ROLLER SCREW
18	F45-2302	BAIL ARM
19	B84-2102	BAIL ARM SCREW
20	F44-6302	LINE ROLLER COLLAR
21	F44-6202	LINE ROLLER WASHER
22	F05-5601	BALL BEARING A
23	F45-4902	LINE ROLLER
24	F60-3401	BAIL
25	F40-1001	BAIL HOLDER WASHER
26	E46-2101	BAIL TRIP LEVER
27	F80-0701	BAIL SPRING
28	F31-4315	BAIL SPRING COVER
29	E24-8101	BAIL SPRING COVER SCREW
30	F35-2410	BAIL TRIP COVER

Key No.	Parts No.	Parts Name
31	F83-8601	BEARING RET
32	E33-0402	BEARING RET SCREW
33	F64-1401	ROLLER CLUTCH RET
34	F84-4801	SPACING SLEEVE A
35	F64-1201	ROLLER CLUTCH
36	L03-6502	BALL BEARING B
37	F74-7701	PINION GEAR
38	F74-8901	BODY
39	F12-2001	A/R CAM SPRING
40	F67-6909	A/R LEVER
41	F13-1601	OSC GEAR COLLAR
42	F74-7801	OSC GEAR
43	E52-0201	DRIVE GEAR
44	373-7808	DRIVE GEAR WASHER
45	631-6901	BALL BEARING C
46	F74-9001	SIDE COVER
47	B83-5002	SIDE COVER SCREW
48	F72-1201	HANDLE COLLAR
49	F67-6502	HANDLE SCREW
50	F75-3101	HANDLE
52	F81-7701	SPACING SLEEVE B
53	F83-3100	BEARING RET WASHER

RG-X4000iA Special Parts

Key No.	Parts No.	Parts Name
2-9	F70-4601	SPOOL
16	F68-7902	ROTOR
24	F60-3601	BAIL
25	E49-6501	BAIL TRIP LEVER