

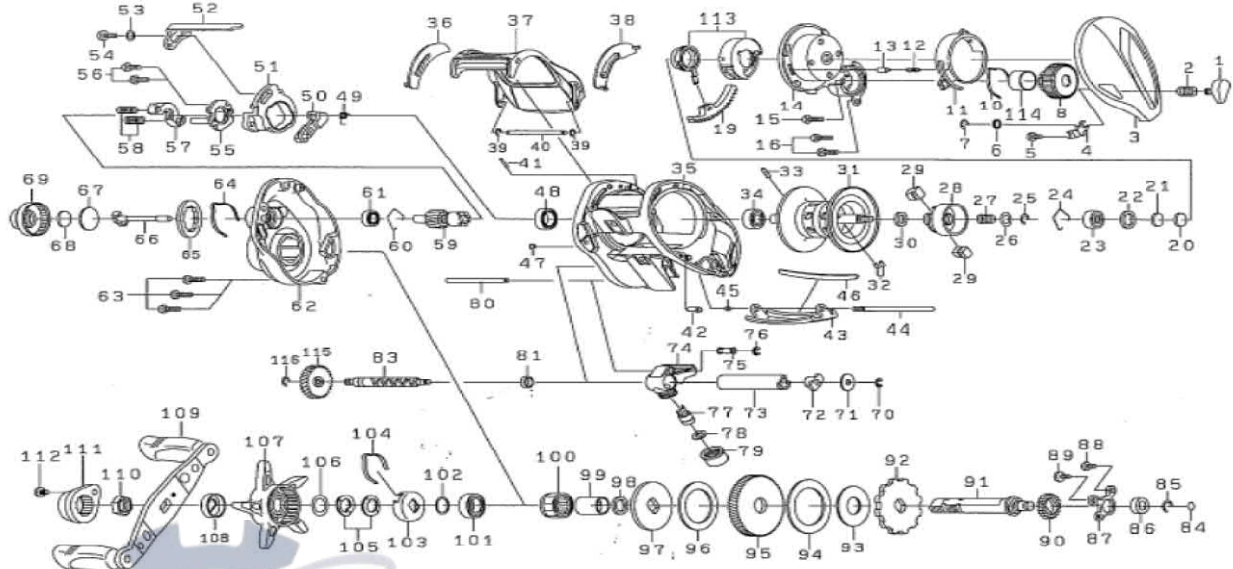

BAITCASTING REEL **T3 BLS 100XSL**



Key No.	Part No.	Part Name	Key No.	Part No.	Part Name
1	H67-1502	PUSH BUTTON AS	65	F62-5502	WASHER (C)
2	H66-4001	SPRING	66	H15-9601	PINION SHAFT
3	H67-1002	RIGHT SIDE PLATE	67	H44-9401	SPACER (F)
4	H67-1701	PLATE (A)	68	B17-5503	SPACER (G)
5	H58-5401	SCREW (A)	69	H65-8302	CAST CONTROL CAP
6	F03-7402	WASHER (A)	70	320-5901	WORM SHAFT RETAINER (A)
7	B86-4101	RETAINER (A)	71	373-1306	WORM SHAFT WASHER
8	H80-8004	BRAKE ADJUSTING KNOB (A)	72	F79-5802	WORM SHAFT SPACER (A)
10	H66-3401	BRAKE CLICK SPRING	73	H68-8701	LEVEL WIND GUARD
11	H89-7601	BRAKE ADJUSTING KNOB (B)	74	H66-0202	T-LEVEL WIND
12	H77-5901	BRAKE ADJUSTING KNOB SPRIN	75	H16-8701	LINE GUIDE COLLAR
13	H28-5601	BRAKE ADJUSTING KNOB PAWL	76	B86-4101	LINE GUIDE RETAINER
14	H67-1301	RIGHT SET PLATE (A)	77	H66-0801	LINE GUIDE PAWL
15	H46-3401	SET PLATE SCREW (A)	78	373-1300	WASHER (D)
16	H66-6001	SET PLATE SCREW (B)	79	F40-2801	LINE GUIDE NUT
19	H80-8301	MAGNET HOLDER GEAR	80	H66-0401	STABILIZER BAR (B)
20	375-7400	SPACER (A)	81	F64-8301	WORM SHAFT BEARING
21	375-7411	SPACER (B)	83	H87-2201	WORM SHAFT
22	G18-5101	SPACER (C)	84	G09-9800	WASHER (E)
23	G51-1503	BALL BEARING (A)	85	320-8002	RETAINER (C)
24	H78-6801	BEARING RETAINER (A)	86	G05-1701	BALL BEARING (D)
25-34	Z02-0645	SPOOL ASSEMBLY	87	H66-0101	PLATE (B)
35	H81-1102	FRAME	88	G17-1402	SCREW (C)
36	H65-9201	SPACER (D)	89	G19-3701	SCREW (D)
37	H65-9402	T-WING	90	H66-0001	DRIVE SHAFT GEAR
38	H65-9201	SPACER (E)	91	H65-9904	DRIVE SHAFT
39	H70-4101	RETAINER (B)	92	H66-0901	CLUTCH WHEEL
40	H65-9802	STABILIZER BAR (A)	93	H66-1101	DRIVE SHAFT WASHER (A)
41	H75-3001	PIN (A)	94	H66-1001	DRIVE SHAFT WASHER (B)
42	H79-1001	PIN (B)	95	H87-1701	DRIVE GEAR
43	H67-1802	FRONT PLATE	96	H35-9001	DRAG WASHER
44	H76-2401	STABILIZER BAR (B)	97	H66-1401	KEY WASHER
45	H76-2301	NUT	98	B55-3803	WASHER (F)
46	H82-0301	FRONT NAME PLATE	99	H58-4401	GEAR SHAFT COLLAR
47	H65-8801	COLLAR (A)	100	F99-9803	ROLLER CLUTCH
48	G43-1004	BALL BEARING (B)	101	G52-3401	BALL BEARING (E)
49	H67-0501	CLUTCH CAM SPRING	102	373-7813	WASHER (G)
50	H80-2301	CLUTCH TRIP LEVER	103	F02-8203	CLICK LEAF SPRING HOLDER
51	H68-8201	CLUTCH CAM	104	F03-2401	CLICK LEAF SPRING (B)
52	H67-0601	CLUTCH CAM PLATE (A)	105	150-8901	DRAG SPRING WASHER
53	H15-9201	WASHER (B)	106	G69-4201	WASHER (H)
54	G19-3701	SCREW (B)	107	H71-7202	STAR DRAG
55	H65-9101	CLUTCH CAM PLATE (B)	108	H66-1701	HANDLE COLLAR
56	H58-1001	CLUTCH CAM SCREW	109	H90-3901	HANDLE ASSEMBLY
57	H86-3801	YOKE	110	H72-3702	HANDLE SCREW (A)
58	H79-8701	YOKE SPRING	111	H72-2002	HANDLE SCREW CAP
59	H87-1601	PINION GEAR	112	G04-0803	HANDLE SCREW (B)
60	E21-9701	BEARING RETAINER (B)	113	Z02-0867	MAGNET HOLDER UN
61	G46-6202	BALL BEARING (C)	114	H80-8601	COLLAR (B)
62	H67-0211	LEFT SIDE PLATE	115	H82-4301	WORM GEAR
63	H66-2201	LEFT SIDE PLATE SCREW	116	B33-9801	WORM SHAFT RETAINER (B)
64	F26-2701	CLICK LEAF SPRING (A)			