

RT55/B (BowGuard version)

55 LBS THRUST

12 VOLT 45 AMPS

52" SHAFT

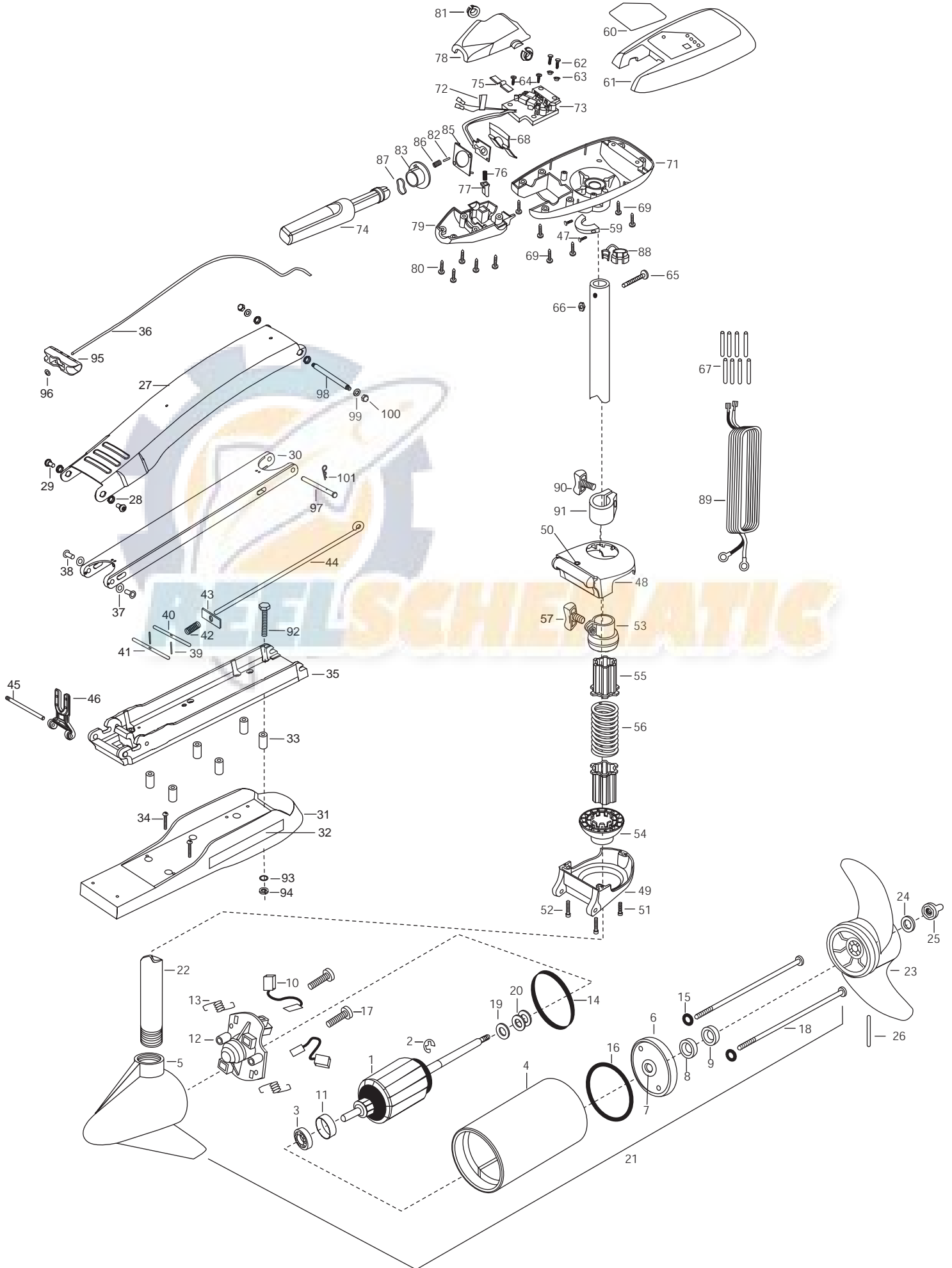

1	92-100-013	ARMATURE ASSEMBLY 12V 3.625	33	2261508	SPACER, MOTOR REST [6 EA.]	66	2333101	NUT-HEX 10-24 UNC-2B NYLOC
2	788-015	RETAINING RING	34	2263434	SCREW 8-18 X 1 PPH SS [2 EA.]	67	2305400	SHRINK TUBE-3/8 OD X 1-1 [8. EA]
3	140-010	BEARING -BALL	35	2993983	BOWPLATE/INSERT ASSEMBLY	68	2302743	SPRING-DETENT -HANDLE-TILT
4	2-200-301	CENTER HOUSING ASSEMBLY 3.625 WHT	36	2251601	ROPE (40"), MAXXUM MOUNT	69	2303412	SCREW-6-20 X 5/8 SELF TAP [6. EA]
5	421-336	HOUSING- BRUSH END 3.625 SW WHI	37	2261707	WASHER 3/8 X 1/2 X .010 SS [2 EA.]	71	2062596	CONTROL BOX, SW, .725 BORE WHT
6	2-400-337	PLAIN END HOUSING ASSEMBLY 3.625	38	2236000	BEARING NYLINER [2 EA.]	72	2305810	TAG-AIR SWITCH LEADS
7	144-049	BEARING - FLANGE [SERVICE ONLY]	39	2152610	SPRING -PIN (LOCKBAR)	73	2334007	CONTROL BOARD ASSEMBLY
8	880-003	**SEAL	40	2233605	LOCKBAR SS (NEW 500)	74	2990915	HANDLE ASSEMBLY W/O U-JOINT
9	880-006	**SEAL WITH SHIELD	41	2233603	LOCK BAR, REAR - SS	75	2302742	SPRING-DETENT(OFF) SS
10	188-036	BRUSH ASSEMBLY [2. EA]	42	2152701	SPRING - (LOCKBAR) SS [2 EA.]	76	2302745	SPRING-RELEASE BUTTON SS
11	725-050	PAPER TUBE- BRUSH RETENTION	43	2262703	SPRING STOP	77	2303720	RELEASE BUTTON-HANDLE
12	738-036	BRUSH PLATE W/HOLDER 3.625	44	2153603	EYE SHAFT 2 LOCKEAR STD	78	2060411	HANDLE (TOP HALF)
13	975-040	SPRING - TORSION [2.EA]	45	2260505	PIN-HINGE (HEADLESS) SS	79	2060415	HANDLE (LOWER HALF)
14	337-036	**GASKET	46	2293811	YOKE, MAX MNT-POLY	80	2303412	SCREW-6-20 X 5/8 SELF TAP [5. EA]
15	701-008	**O-RING [2. EA]	47	2233434	SCREW- #8X3/4 PPH TYPE 25 SS [2.EA]	81	2060005	BEARING-HANDLE PIVOT [2. EA]
16	701-081	**O-RING	■	2991846	BOWGUARD ASSEMBLY SW WHT HC	82	2302600	PIN-ACTUATOR
17	830-007	SCREW # 8-32 [2.EA]	48	2261968	BRKT BASE TOP/INSERT ASSY. WHT	83	2302850	ACTUATOR-CAM
18	830-042	THRU BOLT 10-32 X 8.83 [2. EA]	49	2991877	BRKT BTM/BEARING SW W	85	2302851	ACTUATOR-FWD/REV
19	990-067	WASHER - STEEL THRUST	50	2772352	EYELET SERVICE KIT	86	2302740	SPRING- (ACTUATOR)
20	990-070	WASHER - NYLATRON [2. EA]	51	9954533	SCREW 1/4-20 X 3/4" SS	87	2302741	SPRING-CAM (ZNC PLTD STEEL)
21	2099095	MOTOR- ASSEMBLY 12V 3.62 SW VARS	52	2263404	SCREW 1/4-20 X 2 1/4" [2 EA.]	88	2052900	STRAIN RELIEF-C.CORD/SP.C
22	2032034	TUBE-CARBON COMPOSITE 52" WHT	■	2884701	SLEEVE/INSERT KIT	89	2090600	LEADWIRE (10 GA) (RINGS)
■	1378122	PROPELLER KIT	53	2261525	SPRING-SLEEVE UPPER	90	2011366	SCREW-COLLAR/NEW KNOB (SS)
23	2091150	PROPELLER (W.WEDGE)	54	2261535	SPRING-SLEEVE LOWER	91	2031520	COLLAR-DEPTH (W/O INSERT)
24	2151726	WASHER- 5/16 STD	55	2264702	INSERT -TUBE BOWMOUNT	■	2994830	BAG ASSEMBLY
25	2198400	ANODE-ZINC 3.25/3.625 LWR U	56	2262705	SPRING, BOWGUARD, SS	*92	2263431	SCREW 1/4-20 X 3.5 PPH [6. EA]
26	2092600	PIN-DRIVE	57	2011366	SCREW COLLAR/NEW KNOB SS	*93	2261713	WASHER-1/4 FLAT S/S [6. EA]
■	2991845	MOUNT,BOW ASSEMBLY,SW STD	58	2151700	WASHER-EYE SHAFT(.562 OD)	*94	2263103	NUT-1/4-20 NYLOCK-JAM S/S [6. EA]
■	2771843	BOWGUARD 360 ASSEMBLY	59	2061517	COLLAR-CTRL BOX SW WHT	95	2150400	PULL GRIP (RAW)
27	2264244	ARM-UPPER SW TXT WHT	60	2095681	DECAL-COVER, RT55/B HC	96	2151700	WASHER-EYE SHAFT (.562 OD)
28	2293501	BUSHING, STAINLESS STEEL [4 EA.]	61	2300219	COVER- CONTROL BOX RIPTIDE WHT	97	2262606	PIN-CLEVIS SS MAXXUM BWGR
29	2263500	BOLT, SHOULDER (MAXXUM) [2 EA.]	62	2301310	SCREW-8-18 X 1/2 SS [2. EA]	98	2262604	PIN-BWGR UPPER THREADED
30	2994310	ARM-LOWER ASSEMBLY, STD,SW,EX/M	63	2301710	WASHER-INSUL. (TRANSF.BAR) [2. EA]	99	2661722	WASHER-FLAT 5/16 SS [2 EA.]
31	2263914	MOTOR REST STD MAXXUM WHT	64	2372100	SCREW-8-18 X 5/8 THD (SS) [2. EA]	100	2223100	NUT TENSION 5/16-18 SS [2 EA.]
32	2065676	DECAL-MOTOR REST RT-W [2 EA.]	65	2263406	SCREW-10-24 X 2" SS PPH	101	2260800	CLIP-SPRING SS MAXXUM BG

**Seal & Oring Kit P/N 2888460

* This item is part of an assembly. This item cannot be sold separately due to machining and /or assembly that is required.

P/N 2194927 REV. A 7-02

BLACK

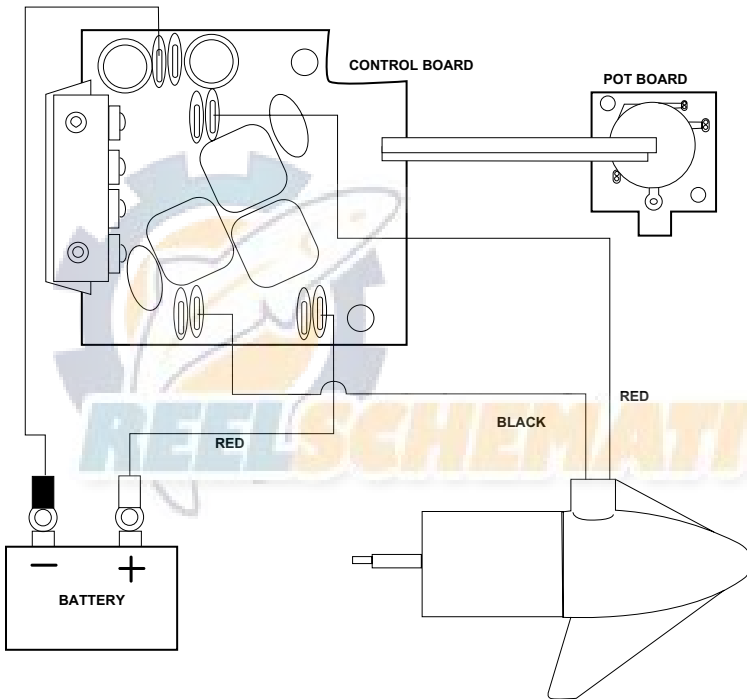

CONTROL BOARD

POT BOARD

RED

BLACK

RED

BATTERY