

RT74/B/H - 3X STEERING
BOWGUARD 360° MOUNT
74 LBS THRUST
24 VOLT 45 AMPS
62" SHAFT

for use with motors with serial numbers beginning MKAE
3-year warranty from the date of purchase

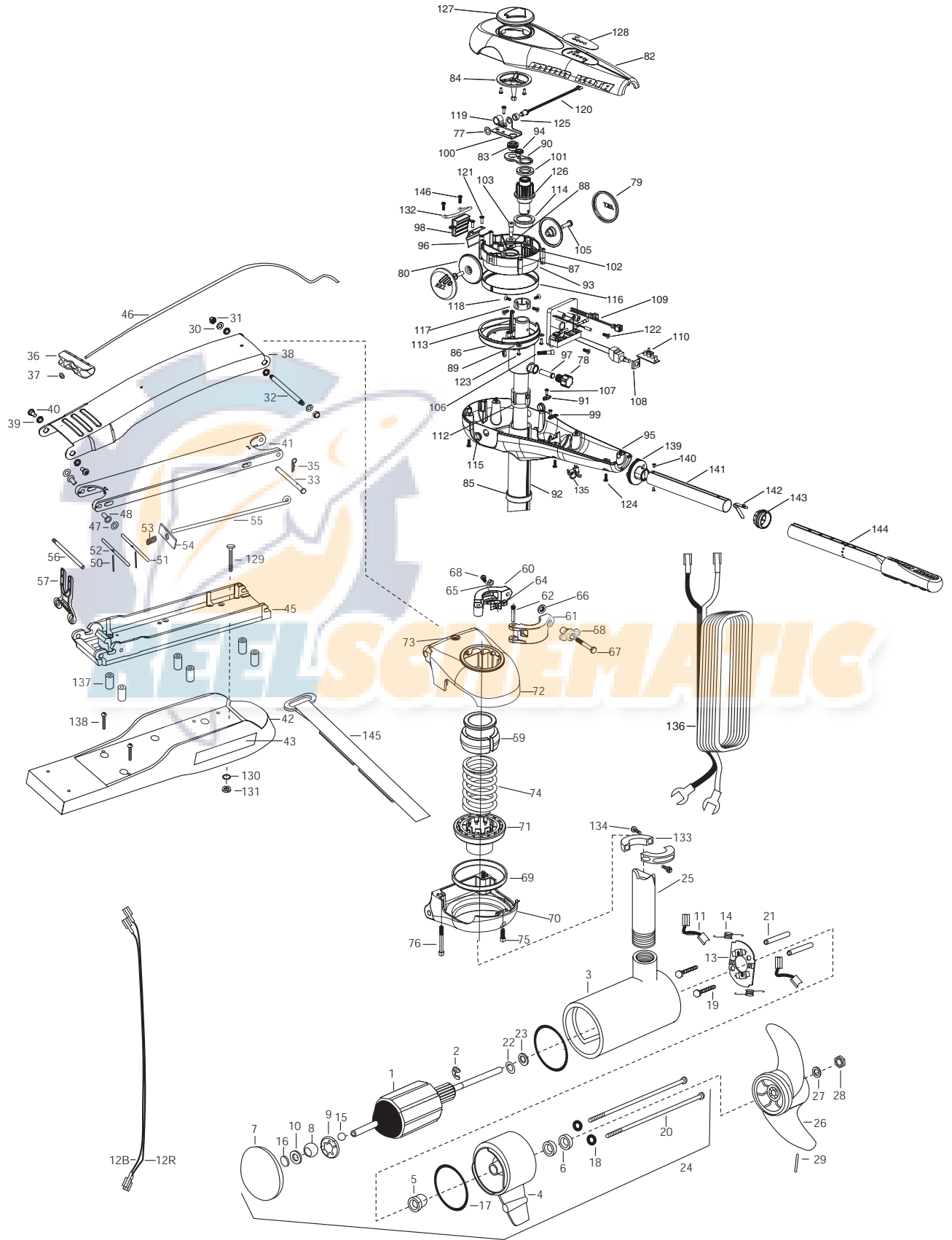

1	2-100-103	ARMATURE ASSEMBLY 24V 4"	52	2233623	LOCK BAR, REAR - SS	102	2073100	NUT - NYLOC [3 EA.]
2	788-040	RETAINING RING	53	2152701	SPRING-LOCKBAR SS	103	2073400	SCREW 5/16"X 1/2" SHOULDER
3	2-200-397	CENTER HOUSING ASSEMBLY 4.0 TXT	54	2262703	SPRING STOP	105	2073408	SCREW [2 EA.]
4	2-300-340	BRUSH END HOUSING ASSEMBLY	55	2153605	EYE SHAFT-2LOCKBAR LONG-SS	106	2073410	SCREW
5	144-017	BEARING- FLANGE (SERVICE ONLY)	56	2260505	HINGE-PIN HEADLESS -SS	107	2073414	SCREW 6-32 PPH [2 EA.]
6	880-025	**SEAL [2.EA]	57	2293811	YOKE,MAX MNT-POLYPROPYLENE	108	2074000	POT CLIP
7	2-400-341	PLAIN END HOUSING ASSEMBLY	■	2991894	BOW GUARD ASSEMBLY	109	2074061	CONTROL BOARD ASSEMBLY
8	144-021	BEARING SPHERICAL	58	2070120	KNOB CLAMP COLLAR	110	2074081	BATTERY METER
9	784-025	BEARING RETAINER	59	2071541	SPRING SLEEVE UPPER	112	2075100	TENSION SLEEVE
10	991-040	WASHER- FELT	■	2991555	COLLAR/CLAMP ASSEMBLY	113	2076700	KEY - TUBE
11	186-094	BRUSH [2.EA]	60	2071550	COLLAR CLAMP "A"	114	2077305	BEARING UPPER
12B	640-020	LEADWIRE-BLACK 10 AWG 78" (62")	61	2071555	COLLAR CLAMP "B"	115	2077316	BUSHING PIVOT [2 EA.]
12R	640-125	LEADWIRE-RED 10 AWG 79 1/2 (62")	62	2072621	PIN KNURLED	116	2077320	BEARING - GEAR CARRIER
13	738-004	BRUSH PLATE 4"	64	2072821	ORIENTATION BLOCK	117	2071560	COLLAR TUBE
14	975-041	SPRING- TORSION [2.EA]	65	2073100	NUT - NYLOC	118	2223468	SCREW 8-32 [4 EA.]
15	116-025	BALL- STEEL	66	2071718	WASHER NYLON	119	2263201	CLAMP WIRE HARNESS
16	303-043	THRUST DISC- METAL	67	2073412	SCREW 1/4 - 20"HHC	120	2264015	LIGHT INDICATOR
17	701-043	**O-RING [2.EA]	68	2223454	SCREW 10-32 SS	121	2372100	SCREW 8-18 SS [2 EA.]
18	701-009	**O-RING - THRU BOLT [2.EA]	■	2991877	BRACKET/BEARING ASSEMBLY	122	2332101	SCREW 8-32 SS [4 EA.]
19	830-027	SCREW -SELF THREAD 10-32X2 [2.EA]	*69	2261531	BEARING	123	2303412	SCREW 6-20 [2 EA.]
20	830-094	THRU BOLT 12-24X10.31 [2.EA]	*70	2262048	BRACKET BASE BOTTOM	124	2303412	SCREW 6-20 X 5/8" [6 EA.]
21	973-025	SPACER- BRUSH PLATE [2.EA]	71	2261535	SPRING SLEEVE	125	2071525	SPACER-INDICATOR LIGHT
22	990-051	WASHER- STEEL	72	2261972	BRACKET BASE TOP	126	2992205	PINION - MAIN
23	990-052	WASHER- NYLATRON	73	2262315	EYELET ROPE	127	2998601	INDICATOR ASSEMBLY
24	2317047	MOTOR ASSEMBLY 24V 4" VARS 62"	74	2262705	SPRING BOWGUARD	128	2075616	DECAL COVER RT 74 W/3X
25	2072012	TUBE- COMPOSITE 3:1 WHITE 62"	75	2263408	SCREW 1/4 - 20" SS	■	2994830	BAG ASSEMBLY - MAXXUM VECTOR
■	1378122	PROPELLER KIT (includes 26-29)	76	2263404	SCREW 1/4 - 20" SHCP SS [2 EA.]	*129	2263431	1/4-20X3.5" PPH [6.EA]
26	2331120	PROPELLER W/WEDGE	77	2013100	SPEED NUT	*130	2261713	WASHER 1/4 FLAT SS [6.EA]
27	2091701	WASHER-5/16 SS	78	2070105	KNOB-TENSION	*131	2263103	NUT 1/4-20 NYLOC-JAM SS [6.EA]
28	2198401	ANODE	80	2070110	PIVOT KNOB [2 EA.]	132	2072815	BRACKET-TILT STOP
29	2092600	PIN-DRIVE	79	2070118	COVER-PIVOT KNOB	133	2261622	COLLAR HALF [2 EA.]
30	2261722	WASHER 1/4 FLAT ZINC [2.EA]	82	2070206	COVER 3:1	134	2263453	SCREW 1/4-20 X1" [2 EA.]
31	2223100	NUT 5/16-18 SS [2 .EA]	83	2070800	COUPLER SOCKET	135	2052900	STRAIN RELIEF
32	2262604	PIN- BWGRD UPPER THREADED	84	2070810	COUPLER DRIVE	136	2090650	LEADWIRE
33	2262606	CLEVIS PIN SS MAXXUM BWGRD	85	2071500	BEARING-LOWER	■	2994832	BAG ASSEMBLY-MAXXUM VECTOR
35	2260800	SPRING CLIP	86	2071513	YOKE-PIVOT	*137	2261505	SPACER, MOTOR REST [6.EA]
36	2150400	PULL-GRIP	87	2071710	WASHER NYLATRON [2 EA.]	*138	2263434	SCREW, 8-18 X 1" PPH SS [2.EA]
37	2151700	WASHER-EYE SHAFT(.562 OD)	88	2071712	WASHER SS	139	2990404	PIVOT HANDLE ASSEMBLY
■	2991847	MOUNT, BOW ASSEMBLY	89	2071714	WASHER FLAT #6 [2 EA.]	140	2072102	SCREW #6 X 1/4" [2 EA.]
38	2264249	ARM-UPPER SW, LONG	90	2071900	IDLER PLATE	141	2070425	HANDLE TUBE
39	2293501	BUSHING, STAINLESS STEEL [4.EA]	91	2071905	BRACKET- SENSOR SWITCH	142	2070411	LATCH-BUTTON
40	2263500	BOLT- SHOULDER (MAXXUM) [2.EA]	92	2072092	OUTER TUBE 3:1 62"	143	2070010	BEARING
41	2994320	ARM-LOWER ASSEMBLY, LONG, SW, EXT	93	2072210	GEAR CARRIER	144	2990930	HANDLE ASSEMBLY-EXT.
42	2263915	MOTOR REST LONG MAXXUM	94	2072215	GEAR- IDLER	145	2263804	STRAP - HOLD DOWN
43	2265676	DECAL-MAXXUM, MOTOR REST [2.EA]	95	2072502	CONTROL BOX	■	2994841	STABILIZER / STRAP BAG ASSEMBLY
45	2993982	BOWPLATE, LONG SW-MACH/INSERT	96	2072705	SPRING DETENT	146	2332101	SCREW #8-32 X 1/2" SS [2 EA.]
46	2251601	ROPE (40"), MAXXUM MOUNT	97	2072710	SPRING TENSION SLEEVE			
47	2261707	WASHER-3/8X1/2X.010" SS [2.EA]	98	2072810	DETENT BLOCK-TILT			
48	2236000	BEARING NYLINER-[2.EA]	99	2072811	DETENT BLOCK-SWITCH			
50	2152612	SPRING-PIN LOCKBAR [2.EA]	100	2072900	RETAINER COUPLER			
51	2233621	LOCK BAR- BOW MOUNT-SS	101	2073000	RING PRELOAD			

**Seal & Oring Kit P/N 2889460 * This item is part of an assembly. This item cannot be sold separately due to machining and /or assembly that is required.

P/N 2074907

REV.A 8-03

