

ENDURA PRO 32  
32 LBS THRUST  
12 VOLT 32 AMPS  
30" SHAFT

for use with "MKAF" serial numbers  
3-year warranty from the date of purchase

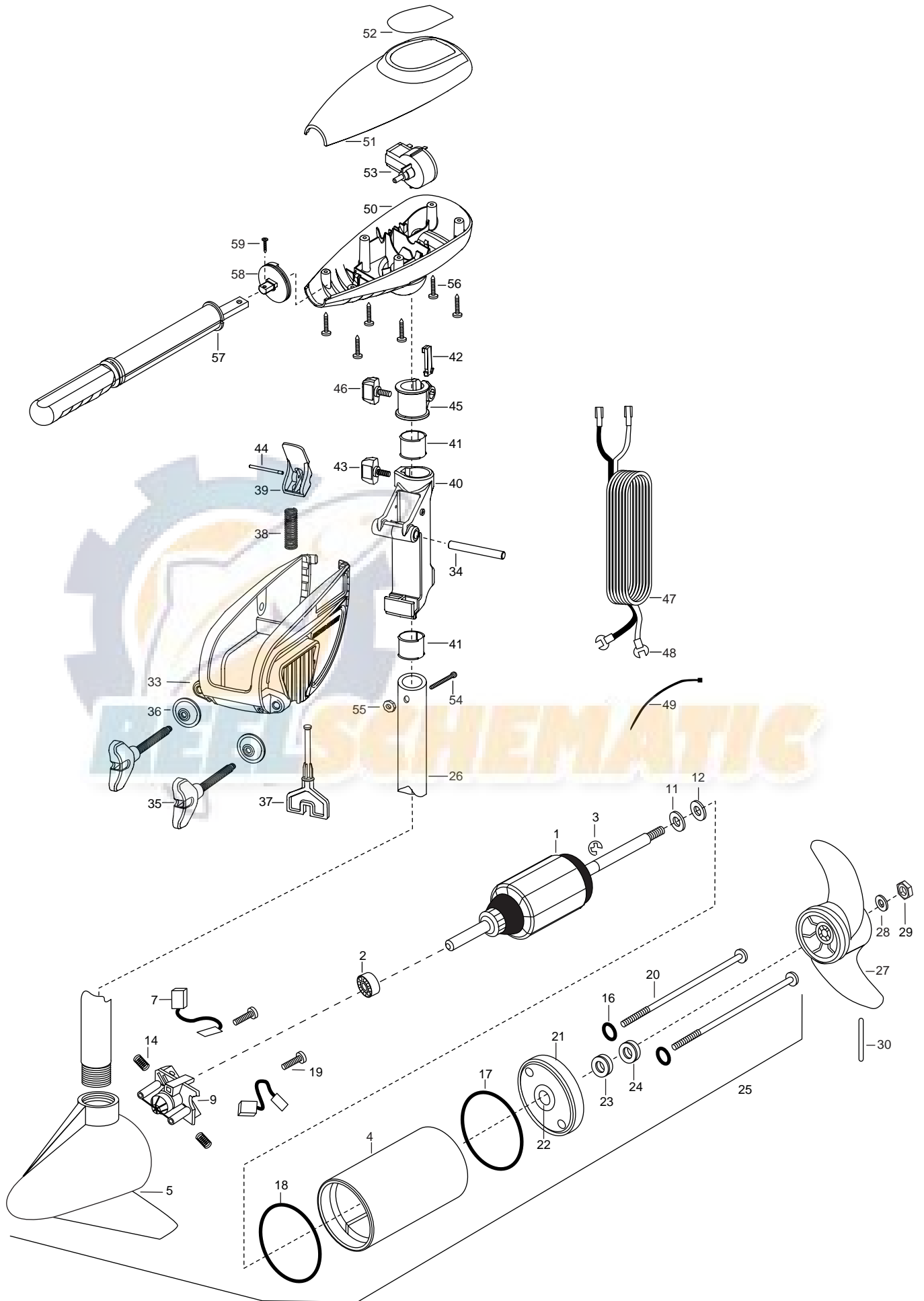

1	2-100-277	ARMATURE ASSEMBLY 12V 3.25			INCLUDES 21, 22, 23, 24	42	2062800	TENSION BLOCK-SNAP IN
	SK2-100-077	ARMATURE ASSEMBLY 12V 3.25		SK423-127	HOUSING- PLAIN END PLAST ASSEMBLY	43	2011385	SCREW, TENSION/KNOB
2	140-010	BALL BEARING	22	144-049	BEARING- FLANGE	44	2060515	PIN, TILT LEVER
3	788-015	RETAINING RING		SK144-049	BEARING-FLANGE	45	2061520	COLLAR-DEPTH ENDURA
4	2-200-177	CENTER HOUSING ASSEMBLY 3.25 TXT	23	880-003	SEAL	46	2011365	SCREW-COLLAR/NEW KNOB
	SK2-200-177	CENTER HOUSING ASSEMBLY 3.25 TXT		SK880-003	SEAL	47	2020605	LEADWIRE- 14 GA SPADE TERM
5	2-300-142	BRUSH END HOUSING ASSEMBLY 3.25 SP CO	24	880-006	SEAL W/SHIELD	48	2020703	TERMINAL-SPADE 14GA. [2.EA]
	SK2-300-142	BRUSH END HOUSING ASSEMBLY 3.25 SP CO		SK880-006	SEAL W/SHIELD	49	2256300	TIE WRAP
7	188-052	BRUSH ASSEMBLY	25	2069260	MOTOR ASSEMBLY 12V 3.25 5SPC TXT	50	2062510	CONTROL BOX ENDURA
9	738-030	BRUSH PLATE W/HOLDER 3.25 ASSEMBLY	25A	2067060	MOTOR ASSEMBLY 12V 3.25 5SPC TXT	51	2060214	CONTROL BOX COVER BLACK
	SK738-030	BRUSH PLATE W/HOLDER 3.25 ASSEMBLY	26	2032045	TUBE, COMPOSITE 30"	52	2065648	DECAL COVER ENDURA PRO 32
11	990-067	WASHER- STEEL	■	1378121	PROP KIT	53	2064023	SWITCH-FWD/REV 5 SP
	SK990-067	WAHER-STEEL	27	2061121	PROPELLER- 3.25 DIA HUB	54	2033401	SCREW-10-24X1-3/4 PPH Z/P
12	990-070	WASHER- NYLATRON	28	2151726	WASHER- 5/16 STD SS	55	2013110	NUT-10-24 HEX ZCP
	SK990-070	WASHER - NYLATRON	29	2053101	NUT- NYLOC 5/16 SS	56	2012100	SCREW-8-18X5/8 THD CUT [6.EA]
14	975-032	SPRING- COMPRESSION	30	2092600	PIN-DRIVE	57	2990901	HANDLE ASSEMBLY 5 SPEED
	SK975-032	SPRING- COMPRESSION	■	2771818	BRACKET & HINGE ASSY (INCLUDES- 33—45)	58	2060405	PIVOT, HANDLE
16	701-007	O-RING [2.EA]	■	2771910	BRACKET ASSEMBLY (INCLUDES- 33,35,36)	59	2012102	SCREW
	SK701-007	O-RING [2.EA]	*33	2061910	BRACKET			
17	701-039	O-RING MK406460	34	2060510	PIN-HINGE			
	SK701-039	O-RING MK406460	■	2881300	SCREW CLAMP, WASHER, RETAINER KIT [2.EA]			
18	701-041	O-RING	*35	2061300	SCREW-CLAMP [2.EA]			
	SK701-041	O-RING	*36	2011710	WASHER-CLAMP SCREW [2.EA]			
19	830-001	SCREW- SELF THREAD 8-32X1.7 [2.EA]	37	2063605	T-BAR, PLASTIC			
	SK830-001	SCREW- SELF THREAD 8-32X1.7 [2.EA]	38	2062706	SPRING- (T-BAR)			
20	830-076	THRU BOLT 8-32X8.0 [2.EA]	39	2067201	LEVER-TILT BLACK			
	SK830-076	THRU BOLT 8-32X8.0 [2.EA]	40	2061810	HINGE-PLASTIC			
21	423-127	HOUSING- PLAIN END PLAST ASSEMBLY	41	2037301	BUSHING-HINGE [2.EA]			

\* This item is part of an assembly. This item cannot be sold separately due to machining and /or assembly that is required.

P/N 2064933 REV.C 5-04

\*When ordering replacement parts for lower motor assembly, only identify motor assembly part number- item 25 and 25A. For motor assembly 2067060, order parts with "SK" prefix.

