

RT101/B/H - 3X STEERING
BOWGUARD 360° MOUNT
101 LBS THRUST
36 VOLT 46 AMPS
62" SHAFT

for use with "AG" serial numbers
3-year warranty from the date of purchase

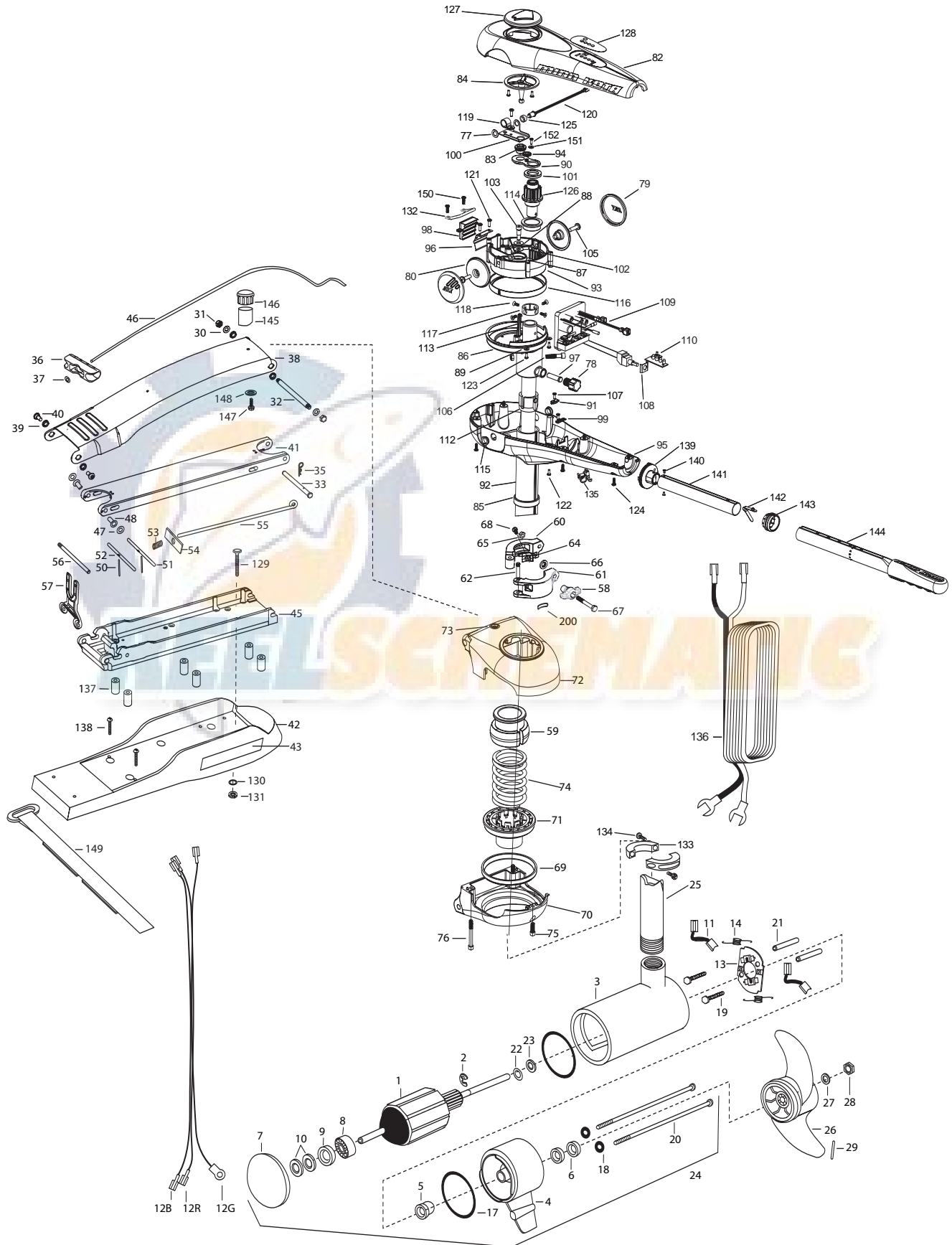

1	2-100-216	ARMATURE ASSEMBLY 36V 4 VARS FW 101#	53	2152701	SPRING-LOCKBAR SS	105	2073408	SCREW [2 EA.]
2	788-040	RETAINING RING	54	2262703	SPRING STOP	106	2073410	SCREW
3	2-200-310	CENTER HOUSING ASSEMBLY 4.0 FW TXT MAX	55	2153605	EYE SHAFT-2LOCKBAR LONG-SS	107	2073414	SCREW 6-32 PPH [2 EA.]
4	2-300-340	BRUSH END HOUSING ASSEMBLY 4.0 FW TXT	56	2260505	HINGE-PIN HEADLESS-SS	108	2074000	POT CLIP
5	144-017	BEARING -FLANGE (SERVICE ONLY)	57	2293811	YOKE,MAX MNT-POLYPROPYLENE	109	2074061	CONTROL BOARD ASSEMBLY
6	880-025	**SEAL [2.EA]	■	2991765	BOW GUARD ASSEMBLY	110	2074082	BATTERY METER
7	421-376	PLAIN END HOUSING ASSEMBLY 4.0	58	2070120	KNOB CLAMP COLLAR	112	2075100	TENSION SLEEVE
8	144-021	BALL BEARING	59	2071541	SPRING SLEEVE UPPER	113	2076701	KEY - TUBE
9	990-045	THRUST SPACER	■	2991555	COLLAR/CLAMP ASSEMBLY	114	2077305	BEARING UPPER
10	992-010	SPRING WASHER [2.EA]	60	2071550	COLLAR CLAMP "A"	115	2077316	BUSHING-PIVOT [2 EA.]
11	188-094	BRUSH 4"W/TERMINAL [2.EA]	61	2071555	COLLAR CLAMP "B"	116	2077320	BEARING - GEAR CARRIER
12B	640-020	BRUSH WIRE-BLACK 10 AWG 78 (62")	62	2072621	PIN KNURLED	117	2071560	COLLAR TUBE
12R	640-125	BRUSH WIRE-RED 10 AWG 79 1/2 (62")	64	2072821	ORIENTATION BLOCK	118	2223468	SCREW 8-32 [4 EA.]
13	738-004	BRUSH PLATE - 4" TERMINAL	65	2073102	NUT	119	2263201	CLAMP WIRE HARNESS
14	975-041	SPRING -TORSION [2.EA]	66	2071718	WASHER #10 NYLON	120	2264015	LIGHT INDICATOR
17	701-043	**O-RING [2.EA]	67	2073412	SCREW 1/4 - 28"HHC	121	2372100	SCREW 8-18 SS [2 EA.]
18	701-009	**O-RING-THRU BOLT (2 REQ'D)	68	2073418	SCREW 10-32 SS	122	2073416	SCREW 8-32 SS SHCS [2 EA.]
19	830-027	SCREW -SELF TREADED 10-32 X 2" [2.EA]	■	2991772	BRACKET/BEARING ASSEMBLY	123	2303412	SCREW 6-20 [2 EA.]
20	830-096	THRU BOLT 12-24 X 11.56" SS [2.EA]	*69	2261531	BEARING	124	2303412	SCREW 6-20 X 5/8" [6 EA.]
21	973-025	SPACER -BRUSH PLATE [2.EA]	*70	2262051	BRACKET BASE BOTTOM	125	2071525	SPACER-LIGHT INDICATOR
22	990-051	WASHER-THRUST, STEEL	71	2261535	SPRING SLEEVE-LOWER	126	2992205	PINION - MAIN
23	990-052	WASHER- NYLATRON	72	2772318	BRACKET BASE TOP W/ EYELET	127	2998601	INDICATOR ASSEMBLY
24	2316287	MOTOR ASSEMBLY 36V VARS TXT 62"	73	2262315	EYELET ROPE	128	2075617	DECAL COVER RT101 W/3X
25	2072012	TUBE (COMP) W/CSK HOLE 62"	74	2262705	SPRING BOWGUARD	■	2994830	BAG ASSEMBLY - MAXXUM VECTOR
■	1378132	PROPELLER KIT	75	2263422	SCREW 5/16-18 X 1" SHCS SS	*129	2263431	1/4-20X3.5" PPH [6.EA]
26	2331160	PROPELLER (W.WEDGE 2)	76	2263424	SCREW 5/16-18 X 2-1/2" SHCS SS [2 EA.]	*130	2261713	WASHER 1/4 FLAT SS [6.EA]
27	2091701	WASHER-PROP (LARGE) MAX 101	77	2013100	SPEED NUT	*131	2263103	NUT 1/4-20 NYLOC-JAM SS [6.EA]
28	2198401	ANODE	78	2070105	KNOB-TENSION	132	2072815	BRACKET-TILT STOP
29	2262658	PROP PIN	79	2070110	PIVOT KNOB [2 EA.]	133	2261622	COLLAR HALF [2 EA.]
30	2261722	WASHER 1/4 FLAT SS [2.EA]	80	2070118	COVER-PIVOT KNOB	134	2263453	SCREW 1/4-20 X 1" [2 EA.]
31	2223100	NUT- TENSION 5/16-18 SS [2 .EA]	82	2070206	COVER 3:1	135	2052900	STRAIN RELIEF
32	2262604	PIN- BWGRD UPPER THREADED	83	2070800	COUPLER SOCKET	136	2090650	LEADWIRE
33	2262606	CLEVIS PIN MAXXUM BWGRD-SS	84	2070810	COUPLER DRIVE	■	2994832	BAG ASSEMBLY-MAXXUM VECTOR
35	2260800	SPRING CLIP	85	2071500	COLLAR LOWER SUPPORT	*137	2261505	SPACER, MOTOR REST [6.EA]
36	2150400	PULL-GRIP	86	2071513	YOKE-GEAR CARRIER	*138	2263434	SCREW, 8-18 X 1" PPH SS [2.EA]
37	2151700	WASHER-EYE SHAFT(.562 OD)	87	2071710	WASHER NYLATRON [2 EA.]	139	2990404	PIVOT HANDLE ASSEMBLY
■	2991847	MOUNT, BOW ASSEMBLY	88	2071712	WASHER SS	140	2072102	SCREW #6 X 1/4" [2 EA.]
38	2264249	ARM-UPPER SW, LONG	89	2071714	WASHER FLAT #6 [2 EA.]	141	2070425	HANDLE TUBE
39	2293501	BUSHING, STAINLESS STEEL [4.EA]	90	2071900	IDLER PLATE	142	2070411	LATCH-BUTTON
40	2263500	BOLT- SHOULDER (MAXXUM) [2.EA]	91	2071905	BRACKET- SENSOR SWITCH	143	2070010	BEARING
41	2994320	ARM-LOWER ASSEMBLY, LONG, FW, EXT	92	2072092	OUTER TUBE 3:1 62"	144	2990930A	HANDLE ASSEMBLY-EXT.
42	2263915	MOTOR REST LONG MAXXUM	93	2072210	GEAR CARRIER	■	2994841	STABILIZER / STRAP BAG ASSEMBLY
43	2065676	DECAL-MAXXUM, MOTOR REST [2.EA]	94	2072215	GEAR- IDLER	145	2268400	SHAFT - SUPPORT
45	2993982	BOWPLATE, LONG SW-MACH/INSERT	95	2072502	CONTROL BOX	146	2268401	BUMPER-SHAFT
46	2251601	ROPE (40"), MAXXUM MOUNT	96	2072705	SPRING DETENT	147	2263464	SCREW 1/4 -10 X 1" SS
47	2261707	WASHER-3/8X1/2X.010" SS [2.EA]	97	2072710	SPRING TENSION SLEEVE	148	2011720	LOCKWASHER
48	2236000	BEARING NYLINER-[2.EA]	98	2072810	DETENT BLOCK-TILT	149	2263804	STRAP - HOLD DOWN
50	2152612	SPRING-PIN LOCKBAR [2.EA]	99	2072811	DETENT BLOCK-SWITCH	150	2332101	SCREW #8-32 X 1/2" SS [2 EA.]
51	2233621	LOCK BAR - BOW MOUNT	100	2072900	RETAINER COUPLER	151	2071720	#4 WASHER SS
52	2233623	LOCK BAR, REAR - SS	101	2073000	RING PRELOAD	152	2373440	#4 SCREW SS
			102	2073100	NUT - NYLOC [3 EA.]	200	2075120	URETHANE PAD
			103	2073400	SCREW 5/16" X 1/2" SHOULDER			

** Seal & Oring Kit P/N 2889460 * This item is part of an assembly. This item cannot be sold separately due to machining and /or assembly that is required.

P/N 2074963

REV.C 6-05

