

EDGE 40 / HC
40 lbs Thrust
12 Volt 42 Amps
45" Shaft

for use with "AG" serial numbers
2-year warranty from the date of purchase

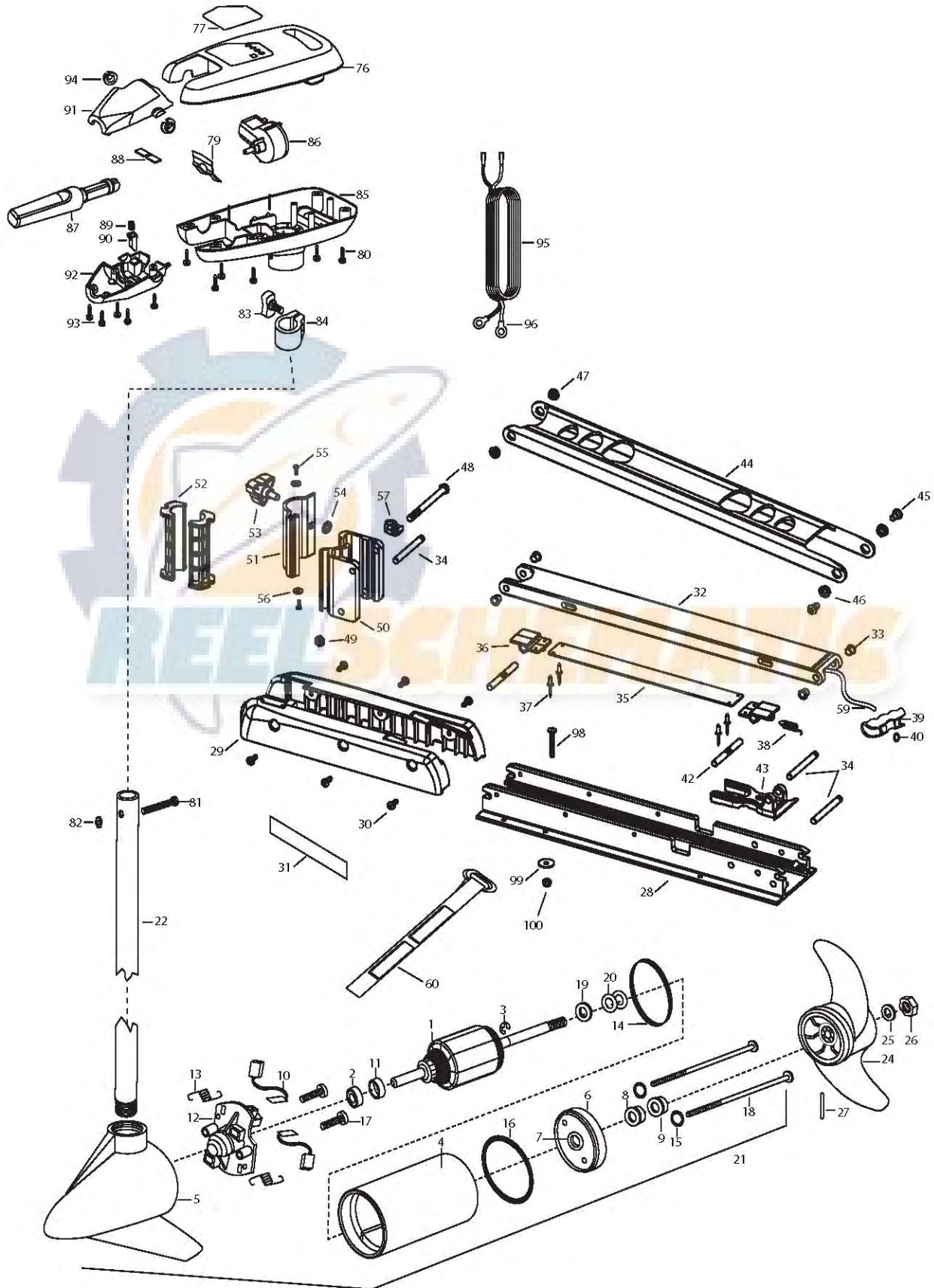

1	2-100-201	ARMATURE ASSEMBLY 12V 3.25	34	2260503	PIVOT PIN [3 EA.]	85	2062551	CONTROL BOX PLAS W/HAND
2	140-010	BEARING-BALL	■	2993811	LATCH STRAP ASSEMBLY, STD, 45"	86	2064023	SWITCH-FWD/REV 5SP
3	788-015	RETAINING RING	35	2263605	LATCH STRAP, STD, 45"	87	2990912	HANDLE ASSEMBLY-W/U-JOINT 5SP
4	2-200-079	CENTER HOUSING ASSEMBLY	36	2261902	BRACKET-LATCH [2 EA.]	88	2302742	SPRING-DETENT OFF
5	2-300-134	BRUSH END HOUSING ASSEMBLY SPDCO	37	2268602	RIVET 1/8" SS [4 EA.]	89	2302745	SPRING-RELEASE BUTTON
6	2-400-128	PLAIN END HOUSING ASSEMBLY	38	2262709	SPRING-LATCH PIN	90	2303720	RELEASE BUTTON-HANDLE
7	144-049	BEARING- FLANGE SERVICE ONLY	39	2150400	PULL-GRIP	91	2060408	HANDLE- TOP HALF
8	880-003	**SEAL	40	2151700	WASHER-EYE SHAFT .562 OD	92	2060415	HANDLE- LOWER HALF
9	880-006	**SEAL-W/SHIELD	42	2260501	LATCH PIN [2 EA.]	93	2303412	SCREW-6-20 X 5/8 SELF TAP [5.EA]
10	188-052	BRUSH ASSEMBLY [2.EA]	43	2261544	YOKE-TUBE	94	2060005	BEARING-HANDLE PIVOT [2.EA]
11	725-050	TUBE- BRUSH RETENTION	44	2264262	ARM-UPPER, FW, STD, 45"	95	2090650	LEADWIRE -10 GA RINGS
12	738-030	BRUSH PLATE WITH HOLDER	45	2263510	BOLT-SHOULDER, SS [2 EA.]	96	2020700	TERMINAL RING, 3/8' [2.EA]
13	975-032	SPRING- COMPRESSION [2.EA]	46	2267302	BUSHING-LOWER 7/16" ID, SS	■	2994838	BAG ASSEMBLY-BOLTS NUTS WASHERS
14	701-039	**O-RING MK406460	47	2267303	BUSHING-UPPER 3/8" ID, SS	*98	2263462	SCREW 1/4-20X2 SS [6.EA]
15	701-007	**O-RING THRU BOLT [2.EA]	48	2263505	BOLT 3/8-16 X 4.25"	*99	2261713	WASHER-1/4 FLAT 18-18 [6.EA]
16	701-041	**O-RING	49	2263114	NUT-NYLOCK JAM 3/8-16	*100	2263103	NUT- 1/4-20 NYLOC-JAM [6.EA]
17	830-001	#8-32 SCREW [2.EA]	50	2261872	HINGE BASE, FW			
18	830-078	THRU BOLT 8-32X8.96 [2.EA]	51	2261877	HINGE DOOR, FW			
19	990-067	WASHER- STEEL THRUST	52	2261537	HINGE SLEEVE [2 EA.]			
20	990-070	WASHER-NYLATRON [2.EA]	53	2260900	HANDLE-SOFT GRIP, L&D			
21	2068252	MOTOR ASSEMBLY 12V F/W 3.625 5SPCO	54	2261728	WASHER-RETAINING 3/8"			
22	2032058	TUBE- COMPOSITE-45"	55	2053415	SCREW #8-32 X 3/8" TRI [2 EA.]			
■	1378126	PROPELLER KIT	56	2261732	WASHER #8, NYLON [2 EA.]			
*24	2061125	PROPELLER- W/WEDGE	57	2262310	ROPE GUIDE			
*25	2151726	WASHER- 5/16 SS	59	2251601	ROPE- 44.5"			
*26	2053101	NUT-PROP NYLOC	60	2263805	VELCRO STRAP			
*27	2092600	PIN-DRIVE	76	2060285	COVER-CONTROL BOX			
28	2266502	BOWPLATE, FW, STD, 45"	77	2265676	DECAL-COVER EDGE 40/H			
29	2263905	MOTOR REST, BLK.	79	2302743	SPRING-DETENT HANDLE-TILT			
30	2303430	SCREW 1/4-20 X 5/8 [6 EA.]	80	2303412	SCREW-6-20 X 5/8 SELF TAP [6.EA]			
31	2265667	MOTOR REST DECAL, FW [2 EA.]	81	2033400	SCREW-10-24 X 1-3/4]			
■	2991700	BOWMOUNT FW ASSEMBLY	82	2013110	NUT-10-24 HEX (ZCP)			
32	2264342	LOWER ARM, FW, STD.	83	2011365	SCREW-COLLAR/NEW KNOB			
33	2266002	NYLINER 3/8" SHAFT [4 EA.]	84	2031520	COLLAR-DEPTH W/O INSERT			

** Seal & Oring Kit P/N 2883460 * This item is part of an assembly. This item cannot be sold separately due to machining and /or assembly that is required.

