

MAXXUM 101 FC
101 lbs Thrust
36 Volt 46 Amps
52 & 62" SHAFT

for use with "AG" serial numbers
3-year warranty from the date of purchase

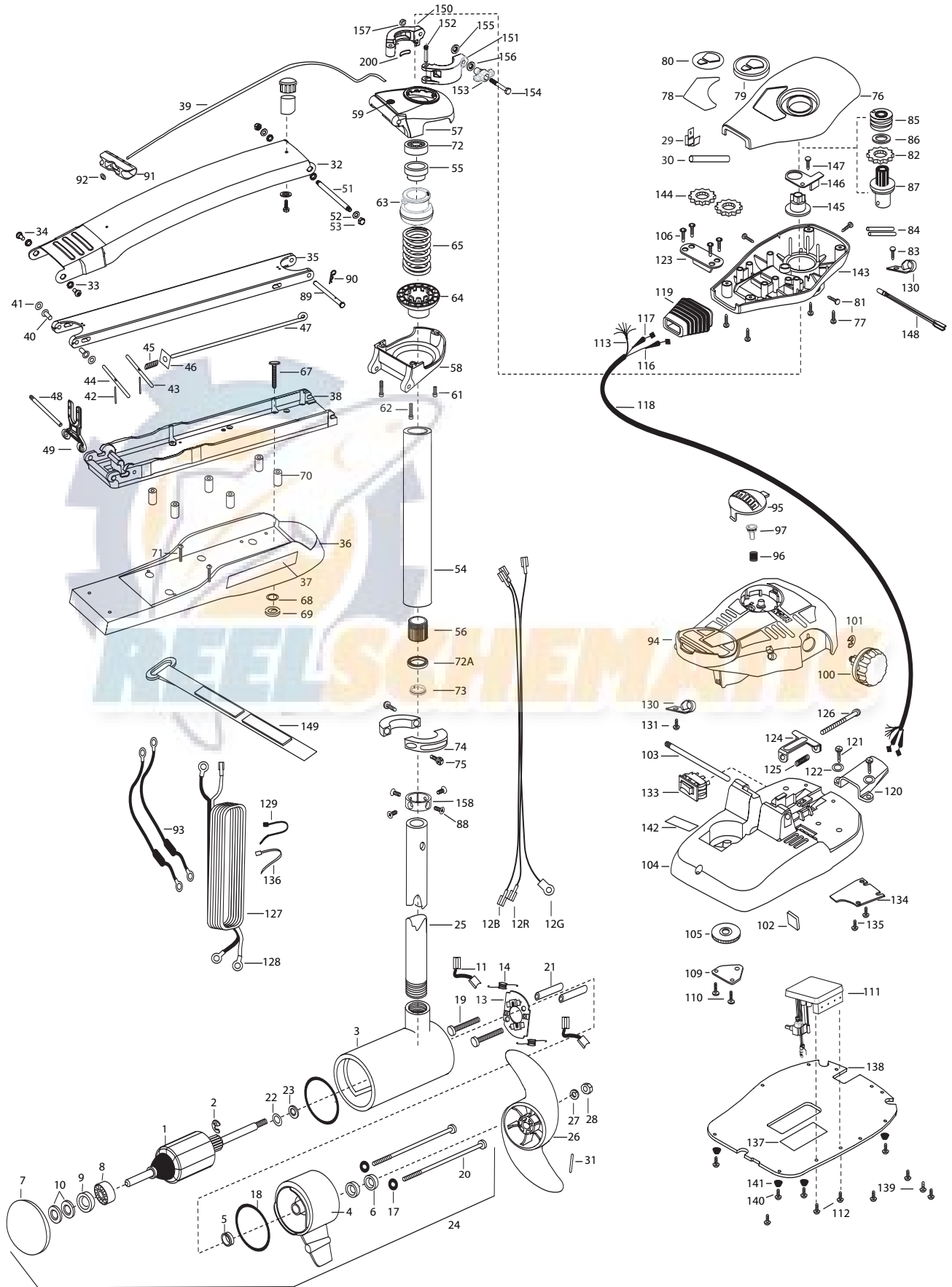

1	2-100-216	ARMATURE ASSEMBLY 36V 4 VARS FW 101#	52	2261722	WASHER 1/4 FLAT ZINC [2.EA]	109	2266401	COVER-PULLEY STAMPING
2	788-040	RETAINING RING	53	2223100	NUT-TENSION 5/16-18 SS [2.EA]	110	2301310	SCREW-8-18 X 1/2" SS [2.EA]
3	2-200-110	CENTER HOUSING ASSEMBLY 4.0 FW TXT MAX	■	2772086	TUBE W/BEARING RACE ASSEMBLY 52"	111	2264052	CONTROL BOARD ASSEMBLY- MAX101
	2-200-120	CENTER HOUSING ASSEMBLY 4.0 FW SONAR		2772087	TUBE W/BEARING RACE ASSEMBLY 62"	112	2223455	SCREW 10-32 X 1/2 [2.EA]
4	2-300-160	BRUSH END HOUSING ASSEMBLY 4.0 FW TXT	54	2272086	TUBE OUTER -24" 4 HOLES 52"	113	2261220	WIRE HARNESS MAX 101
5	144-017	BEARING -FLANGE (SERVICE ONLY)		2272087	TUBE OUTER -34" 4 HOLES 62"	116	2267505	CABLE ASSEMBLY-RIGHT 5'
6	880-025	**SEAL [2.EA]	55	2266260	BEARING RACE- 565T	117	2267515	CABLE ASSEMBLY-LEFT 5'
7	421-276	PLAIN END HOUSING ASSEMBLY 4.0	56	2267307	BUSHING, OUTER TUBE	118	2265430	CABLE JACKET 5'
9421-277 / 9421-278	52"/62"	PLAIN END HOUSING ASSEMBLY 4.0 SONAR	■	2991763	BOWGUARD ASSEMBLY-FT CTRL,MAX	119	2265110	BOOT-CONTROL BOX
8	140-010	BALL BEARING	57	2772319	BRACKET BASE TOP/EYELET ASSEMBLY	120	2265115	BOOT-FOOT PEDAL BASE
9	990-045	THRUST SPACER	58	2771770	BRACKET BOTTOM/BEARING ASSEMBLY	121	2372100	SCREW-8-18 X 5/8",THDT [2.EA]
10	992-010	SPRING WASHER	59	2772352	EYELET-ROPE KIT	122	2261714	WASHER-MAXXUM FT PDL [2.EA]
11	188-094	BRUSH 4"W/TERMINAL [2.EA]	61	2263423	SCREW 5/16-18 X 1" SHCS ZINC	123	2261901	BRACKET-CONDUIT AT/MAX
12B	640-024	BRUSH WIRE- BLACK 10 AWG 79"	62	2263425	SCREW 5/16-18 X 2-1/2" SHCS [2.EA]	124	2263210	BRACKET-CONDUIT ADJUST
12R	640-131	BRUSH WIRE- RED 10 AWG 80-1/2"	63	2071541	SPRING-SLEEVE UPPER	125	2262720	SPRING-CONDUIT ADJUST
13	738-004	BRUSH PLATE - 4" TERMINAL	64	2071535	SPRING SLEEVE, LOWER	126	2263466	SCREW-1/4-20 X 2" STL PPH
14	975-041	SPRING -TORSION [2.EA]	65	2262706	SPRING, BOWGUARD, NIK	127	2261238	LEADWIRE A/T VARIABLE
17	701-009	**O-RING -THRU BOLT [2.EA]	■	2994830	BAG ASSEMBLY-MAXXUM	128	2020700	TERMINAL RING, 3/8" [2.EA]
18	701-043	**O-RING (2 REQ'D)	*67	2263431	SCREW 1/4-20 X 3.5" PPH [6.EA]	129	2256300	TIE WRAP-5.5" BLACK
19	830-027	SCREW -SELF TREADED 10-32 X 2" [2.EA]	*68	2261713	WASHER-1/4" FLAT S/S [6.EA]	130	2263201	CLAMP WIRE HARNESS MICRO [2.EA]
20	830-096	THRU BOLT 12-24 X 11.56" SS [2.EA]	*69	2263103	NUT -NYLOCK JAM 1/4-20 S/S [6.EA]	131	2332103	SCREW-6-20 X 3/8" THD
21	973-025	SPACER -BRUSH PLATE [2.EA]	■	2994832	BAG ASSEMBLY	133	2254031	SWITCH-MOM/OFF/COM
22	990-051	WASHER-THRUST, STEEL	70	2261505	SPACER, MOTOR REST [6.EA]	134	2266412	SWITCH PLATE, FT PEDAL
23	990-052	WASHER- NYLATRON	71	2263434	SCREW, 8-18 X 1" PPH [2.EA]	135	2332103	SCREW-6-20 X 3/8" THD [2.EA]
24	2316285	MOTOR ASSEMBLY 36V VARS TXT (52")	72	2266000	BEARING, BALL-STEEL	136	2256301	TIE WRAP-5.5' WHITE [2.EA]
	2316289	MOTOR ASSEMBLY 36V VARS TXT (62")	72A	2266116	BEARING, CARTRIDGE	137	2365107	INSULATING PAD 2.3 X 3.2"
	2326281	MOTOR ASSEMBLY 36V VARS TXT SONAR (52")	73	2266001	BEARING, SPLIT RING	138	2264511	BOTTOM PLATE, MAX 101
	2326282	MOTOR ASSEMBLY 36V 4" VARS SONAR (62")	74	2261619	COLLAR HALF-ZINC-2 PER	139	2372100	SCREW-8 X 5/8" SS [5.EA]
25	2032006	TUBE (COMP) W/4 HOLE 52"	75	2263452	SCREW- 1/4-20X3/4 SHCP SS [2.EA]	140	2263455	SCREW #12-14 X 1/2" THR FRM [4.EA]
	2032007	TUBE (COMP) W/4 HOLE 62"	76	2260283	CONTROL BOX COVER-MAX	141	2265126	BUMPER PAD, FOOT PEDAL [4.EA]
■	1378132	PROPELLER KIT	77	2372100	SCREW-8-18 X 5/8" THDT [4.EA]	142	2266610	DECAL-ON/OFF SWITCH
26	2331160	PROPELLER (W.WEDGE 2)	78	2265663	DECAL COVER, MAXXUM 101	143	2262535	CONTROL BOX-PLASTIC
27	2091701	WASHER-PROP (LARGE) MAX 101		2265651	DECAL COVER, MAXXUM 101/SONAR	144	2267800	GEAR-INDICATOR [2.EA]
28	2093101	NUT-PROP (LARGE) MAX 101	79	2260150	POINTER DISC TRNSLCNT	145	2262220	INDICATOR-DRIVE
29	2020713	TERMINAL- ADAPTOR MAX50/S	80	2265800	DECAL-INDICATOR	146	2261905	BRACKET/INDICATOR
30	2335400	SHRINK TUBE 1/4ODX2"	81	2053414	SCREW-8-32 X 1/2" TRI-LOBE [3.EA]	147	2301310	SCREW-8-18 X 1/2" SS
31	2262658	PROP PIN	82	2267800	GEAR INDICATOR	148	2264015	LIGHT/INDICATOR
■	2991841	MOUNT, BOW ASSEMBLY W/O BGRD FW MAX	83	2301310	SCREW-8-18 X 1/2" SS	149	2263802	STRAP- HOLD DOWN 30.5 VELCRO
32	2264246	ARM-UPPER FW LG	84	2355410	SHRINK TUBE-3/8 OD X 2" [2.EA]	■	2991550	CLAMP COLLAR ASSEMBLY
33	2293501	BUSHING, STAINLESS STEEL [4.EA]	85	2232360	PULLEY-CABLE DRUM	150	2071550	CLAMP COLLAR "A"
34	2263500	BOLT, SHOULDER [2.EA]	86	2261730	WASHER-NYLON A/T	151	2071555	CLAMP COLLAR "B"
35	2774317	ARM-LOWER ASSEMBLY, LG, FW EXTR	87	2996247	TOP BEARING RACE /PINION DRIVE ASSEMBLY	152	2072621	PIN-KNURLED
36	2263913	MOTOR REST LONG, MAXXUM	88	2223468	SCREW-8-32 X 7/16" ZINC PLATE [4.EA]	153	2070120	KNOB-CLAMP COLLAR
37	2265514	DECAL- MOTOR REST [2.EA]	89	2262607	PIN - CLEVIS ZP MAX BG	154	2073412	SCREW 1/4-28 X 2 3/4" SS
38	2773986	BOWPLATE, LG FW /INSERT	90	2260805	CLIP-SPRING ZP MAX BG	155	2071718	WASHER #10 NYLON RETAINING
39	2251601	ROPE 40" MAXXUM	91	2150400	PULL-GRIP	156	2071716	WASHER - FLAT SS
40	2261708	WASHER-3/8 X 1/2 X.010" SS [2.EA]	92	2151700	WASHER-EYE SHAFT .562"	157	2073102	NUT - HEX 1/4 - 28 SS
41	2236000	BEARING NYLINER [2.EA]	93	2998200	CIRCUIT BREAKER ASSEMBLY 36V-101 [2.EA]	158	2071560	SPLIT COLLAR
42	2152610	SPRING-PIN (LOCKBAR) [2.EA]	94	2790002	FOOT PEDAL/PLUG ASSEMBLY	200	2075120	URETHANE PAD
43	2233600	LOCK BAR- (BOW MOUNT)	95	2993702	PUSH-BUTTON MAGNET ASSEMBLY			
44	2233602	LOCK BAR, REAR - ZINC	96	2302732	SPRING-LOWER PEDAL SS			
45	2152700	SPRING -LOCKBAR	97	2260810	CLIP, REED SWITCH			
46	2262703	SPRING STOP	100	2260160	KNOB-SPEED CONTROL			
47	2153604	EYE SHAFT -2LOCKBAR STD PLTD	101	2263000	E-RING TRU-ARC#5133-43			
48	2260506	HINGE-PIN HEADLESS ZINC	102	2266413	TENSION SCREW PLATE FT			
49	2293811	YOKE, MAXXUM MOUNT POLYPROPYLENE	103	2260511	PIN-PIVOT A/T FT PDL			
■	2994841	BAG ASSEMBLY- MAXXUM STABILIZER	104	2992102	FOOT PEDAL BASE/PIN ASSEMBLY			
51	2262605	PIN- BWGRD UPPER THREADED ZP	105	2262301	PULLEY FOOT PEDAL			
			106	2223430	SCREW- #8 X3/4" PPH TYPE 25 SS [4.EA]			

** Seal & Oring Kit P/N 2889460 * This item is part of an assembly. This item cannot be sold separately due to machining and /or assembly that is required.

