

**MAXXUM 55 FC**  
**55 lbs Thrust**  
**12 Volt 50 Amps**  
**52" SHAFT**

for use with "AG" serial numbers  
3-year warranty from the date of purchase

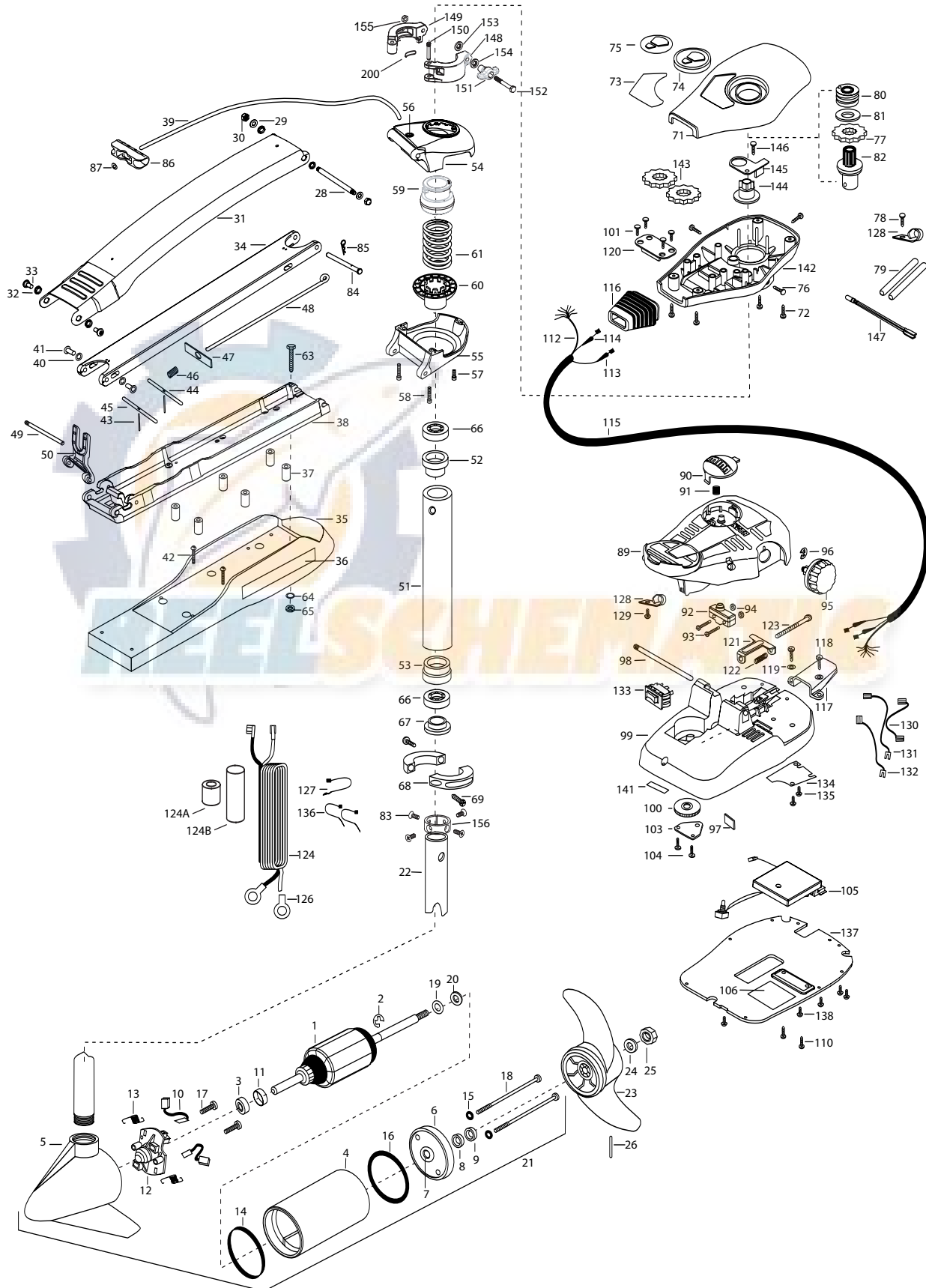

1	2-100-115	ARMATURE ASSEMBLY 12V 3.62 FW SW	■	2772016	TUBE W/BEARING RACE ASSEMBLY	104	2301310	SCREW- 8-18 X 1/2 [4.EA]
2	788-015	RETAINING RING	51	2272067	TUBE OUTER-24" 4 HOLES	105	2264036	CNTROL BOARD ASSEMBLY 12V MAX44
3	140-010	BALL BEARING	52	2266260	BEARING RACE	106	2365107	INSULATING PAD (2.3X3.2)
4	2-200-101	CENTER HOUSING ASSEMBLY 3.62 TXT MAG	53	2266220	BEARING RACE- STEEL	110	2263447	SCREW- 8-32 X 1" [2.EA]
5	421-065	HOUSING BRUSH END 3.62 TXT	■	2991762	BOWGUARD ASSEMBLY- FT CTRL,FW	112	2261219	WIRE HARNESS AT & MAX
6	2-400-101	PLAIN END HOUSING ASSEMBLY	54	2772319	BRACKET BASE TOP/EYELET ASSEMBLY	113	2267505	CABLE ASSEMBLY- RIGHT (5')
7	144-049	BEARING - FLANGE (SERVICE CENTER ONLY)	*55	2991771	BRKT BOTTOM/BEARING FW ASSEMBLY	114	2267515	CABLE ASSEMBLY- LEFT (5')
8	880-003	**SEAL	56	2772352	EYELET- KIT	115	2265430	CABLE JACKET (5')
9	880-006	**SEAL WITH SHIELD	57	2263423	SCREW 5/16-18 X 1" SHCS ZINC	116	2265110	BOOT- CONTROL BOX
10	188-036	BRUSH ASSEMBLY [2.EA]	58	2263425	SCREW 5/16-18 X 2 1/2" SHCS [2.EA]	117	2265115	BOOT- FOOT PEDAL BASE
11	725-050	BRUSH RETENTION- PAPER TUBE	59	2071541	SPRING SLEEVE- UPPER	118	2372100	SCREW- 8-18X5/8 THD [2.EA]
12	738-036	BRUSH PLATE W/HOLDER	60	2071535	SPRING SLEEVE- LOWER	119	2261714	WASHER- MAXXUM FT PDL [2.EA]
13	975-040	SPRING - TORSION [2.EA]	61	2262706	SPRING- BOWGUARD, NIK PL	120	2261901	BRACKET- CONDUIT
14	337-036	**GASKET	■	2994830	BAG ASSEMBLY- MAXXUM	121	2263210	BRACKET- CONDUIT ADJUST
15	701-008	**O-RING, THRU-BOLT [2.EA]	*63	2263431	SCREW- 1/4-20 X 3.5 PPH [6.EA]	122	2262720	SPRING- CONDUIT ADJUST
16	701-081	**O-RING	*64	2261713	WASHER- 1/4 FLAT S/S [6.EA]	123	2263463	SCREW- 1/4-20X2" STL PPH
17	830-007	SCREW- #8-32 [2.EA]	*65	2263103	NUT- 1/4-20 NYLOCK-JAM SS [6.EA]	124	2261227	LEADWIRE- A/T VARIABLE
18	830-042	THRU-BOLT 10-32X8.83 [2.EA]	66	2266000	BEARING BALL- STEEL [2.EA]	124A	2307310	BEAD - FERRITE (CE MODELS ONLY)
19	990-067	WASHER- STEEL THRUST	*67	2266115	BEARING CONE	124B	2075401	HEAT SHRINK 1.10" OD X 3.5" (CE MODELS ONLY)
20	990-070	WASHER- NYLATRON [2.EA]	*68	2261619	COLLAR HALF- ZINC [2.EA]	126	2020700	TERMINAL RING- 3/8" [2.EA]
21	2097090	MOTOR ASSEMBLY 12V FW VARS 55#	*69	2263452	SCREW- 1/4-20X3/4 [2.EA]	127	2256300	TIE WRAP- 5.5' BLACK
22	2032006	TUBE- COMP 52"	71	2260283	CONTROL BOX COVER- MAXXUM	128	2263201	CLAMP WIRE HARNESS MICRO [2.EA]
■	1378131	PROPELLER KIT	72	2372100	SCREW- 8-18 X 5/8 THD [4.EA]	129	2332103	SCREW- 6-20X3/8 THD (SS)
23	2091160	PROPELLER W.WEDGE 2	73	2265656	DECAL- COVER MAX 55/FC	130	2260316	CONNECTING WIRE (VAR.SPD)
24	2151726	WASHER-5/16 SS	74	2260150	POINTER DISC TRNSLCNT RED	131	2260312	WIRE- BLK W/WHT STRP 19 -1/4"
25	2053101	NUT-PROP NYLOC	75	2265800	DECAL- INDICATOR	132	2260323	WIRE- BLK W/GRN STP VARIABLE
26	2092600	PIN-DRIVE	76	2053414	SCREW- 8-32 X 1/2 TRI-LOBE [3.EA]	133	2254031	SWITCH- MOM/OFF/CON
28	2262605	PIN- BWGRD UPPER THREADED ZP	77	2267800	GEAR- INDICATOR	134	2266412	SWITCH PLATE- FT PEDAL
29	2261722	WASHER- FLAT [2.EA]	78	2301310	SCREW- 8-18 X 1/2	135	2332103	SCREW- 6-20X3/8 THD SS [2.EA]
30	2223100	NUT- TENSION 5/16-18 SS [2.EA]	79	2355410	SHRINK TUBE- 3/8 OD X 2" [2.EA]	136	2256301	TIE WRAP- 5.5" WHITE [2.EA]
■	2991841	MOUNT- BOW ASSY, W/O BG LNG FW MAX	80	2232360	PULLEY- CABLE DRUM	137	2774512	BOTTOM PLATE- MAX FOOT PEDAL
31	2264246	ARM-UPPER LNG FW	81	2261730	WASHER- NYLON A/T CON	138	9953104	SCREW-8 X 1/2" (SS) [5.EA]
32	2293501	BUSHING- STAINLESS STEEL [4.EA]	82	2996247	TOP BEARING RACE /PINION DRIVE	141	2266610	DECAL- ON/OFF SWITCH
33	2263500	BOLT- SHOULDER MAXXUM [2.EA]	83	2223468	SCREW- 8-32 X 7/16 [4.EA]	142	2262535	CONTROL BOX- PLASTIC
34	2994317	ARM-LOWER ASSEMBLY,LNG,FW,EXTRA [INCLUDES 39, 43-47, 86,87]	84	2262607	PIN- CLEVIS ZP MAXXUM BWGRD	143	2267800	GEAR- INDICATOR [2.EA]
35	2263913	MOTOR REST LONG MAXXUM	85	2260805	CLIP- SPRING ZP MAX BG	144	2262220	INDICATOR- DRIVE
36	2265514	DECAL- MAXXUM MOTOR REST [2.EA]	86	2150400	PULL- GRIP	145	2261905	BRACKET/INDICATOR
37	2261505	SPACER- MOTOR REST [6.EA]	87	2151700	WASHER- EYE SHAFT(.562 OD)	146	2301310	SCREW- 8-18X1/2"
38	2773986	BOWPLATE- W/INSERT LG FW TXT	89	2790002	FOOT PEDAL/PLUG ASSEMBLY	147	2264015	LIGHT/INDICATOR
39	2251601	ROPE (40"), MAXXUM MOUNT	90	2263700	PUSH- BUTTON FOOT PEDAL	■	2991550	CLAMP COLLAR ASSEMBLY
40	2261708	WASHER- 3/8X1/2X.010 SS [2.EA]	91	2302732	SPRING- LOWER PEDAL	148	2071550	CLAMP COLLAR "A"
41	2236000	BEARING NYLINER [2.EA]	92	2264023	SWITCH- SEALED ASSEMBLY	149	2071555	CLAMP COLLAR "B"
42	2263434	SCREW, 8-18X1" PPH [2.EA]	93	2262114	SCREW- MOUNTING/SWITCH [2.EA]	150	2072621	PIN-KNURLED
43	2152610	SPRING- PIN LOCKBAR [2.EA]	94	2233100	NUT- SWITCH MOUNT [2.EA]	151	2070120	KNOB-CLAMP COLLAR
44	2233600	LOCK BAR- BOW MOUNT	95	2260160	KNOB- SPEED CONTROL (VAR)	152	2073412	SCREW 1/4-28 X 2 3/4" SS
45	2233602	LOCK BAR REAR - ZINC	96	2263000	E-RING THU-ARC	153	2071718	WASHER #10 NYLON RETAINING
46	2152700	SPRING- LOCKBAR CAD.PLTD	97	2266413	TENSION SCREW PLATE FT PEDAL	154	2071716	WASHER - FLAT SS
47	2262703	SPRING STOP- MAXXUM	*98	2260511	PIN- PIVOT A/T FT PDL	155	2073102	NUT - HEX 1/4 - 28 SS
48	2153604	EYE SHAFT- 2LOCKBAR LNG	99	2992102	FT PEDAL BASE/PIN ASSEMBLY	156	2071560	SPLIT COLLAR
49	2260506	HINGE-PIN HEADLESS ZINC	100	2262301	PULLEY- FOOT PEDAL	200	2075120	URETHANE PAD
50	2293811	YOKE- MAXXUM MOUNT,POLYPROPYLENE	101	2223430	SCREW- #8X3/4 PPH TYPE 25 SS [4.EA]			
			103	2266400	COVER- PULLEY			

\*\* Seal & Oring Kit P/N 2888460 \*This item is part of an assembly. This item cannot be sold separately due to machining and /or assembly that is required.

