

**MAX70/SC hand control**  
**70 LBS THRUST**  
**24 VOLT 42 AMPS**  
**52" SHAFT**

**for use with "AH" serial numbers**  
**3-year warranty from the date of purchase**

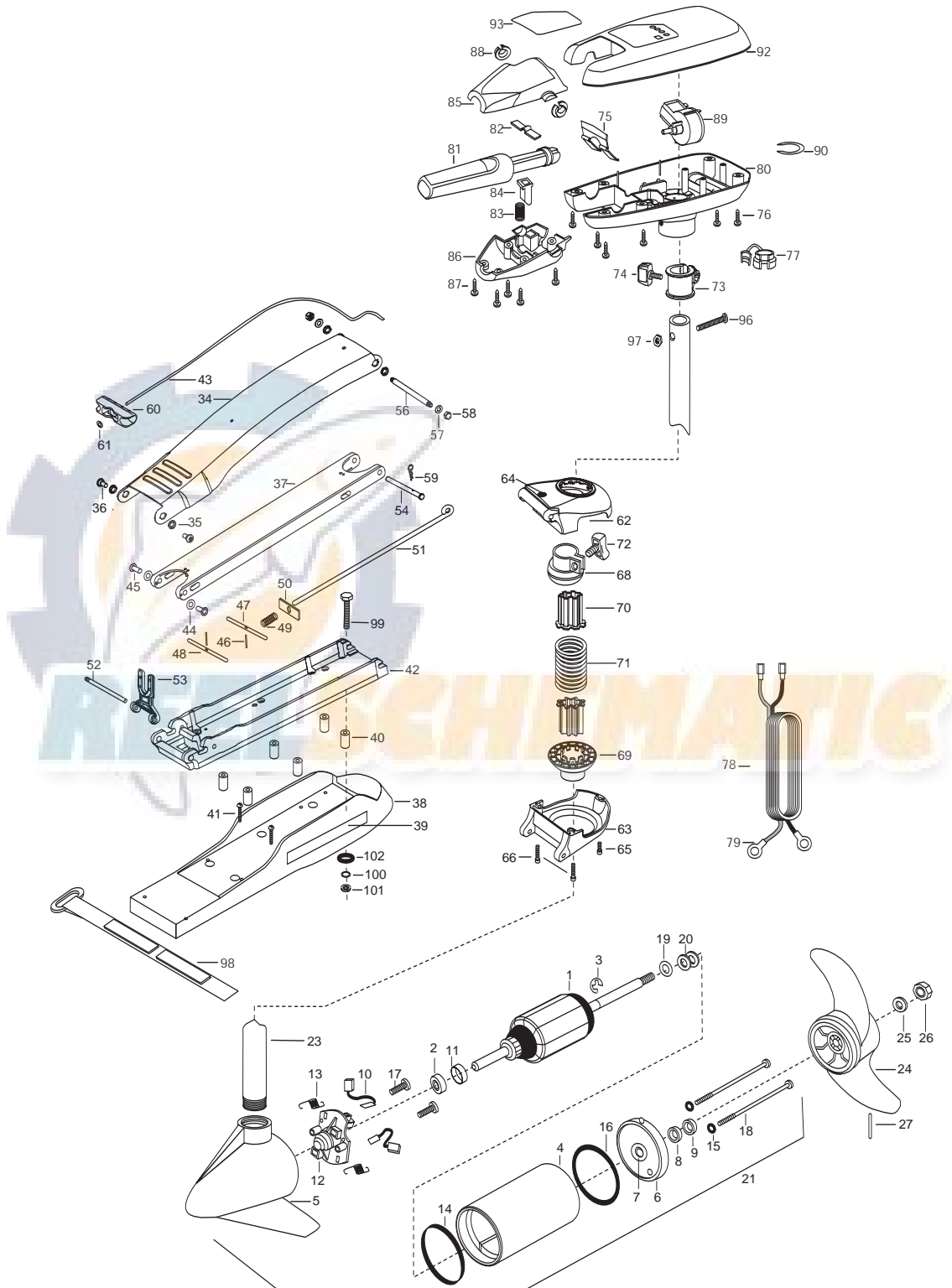

1	2-100-119	ARMATURE ASSEMBLY 24V 3.625 70#	40	2261505	SPACER, MOTOR REST [6.EA]	75	2302743	SPRING-DETENT HANDLE-TILT
2	788-015	RETAINING RING	41	2263434	SCREW- #8-18 X 1 PPH SS [2.EA]	76	2303412	SCREW-#6-20 X 5/8 SELF TAP [6.EA]
3	140-010	BALL BEARING	42	2773987	BOWPLATE W/INSERT	77	2052900	STRAIN RELIEF-C.CORD/SP.C
4	2-200-005	CENTER HOUSING ASSEMBLY 3.625 FW TXT	43	2251601	ROPE (40'), MAXXUM MOUNT	78	2090650	LEADWIRE (10 GA) RINGS
5	2-300-139	BRUSH END HOUSING ASSEMBLY 3.62 SPCO	44	2261708	WASHER-3/8X1/2X.010 [2.EA]	79	2020700	TERMINAL RING, 3/8 [2.EA]
6	2-400-101	PLAIN END HOUSING ASSEMBLY	45	2236000	BEARING NYLINER- [2.EA]	80	2062565	CONTROL BOX
7	144-049	BEARING - FLANGE (SERVICE ONLY)	46	2152610	SPRING-PIN LOCKEAR [2.EA]	81	2990912	HANDLE ASSEMBLY W/O U-JOINT 5SP
8	880-003	SEAL	47	2233600	LOCK BAR- BOW MOUNT	82	2302742	SPRING-DETENT (OFF)
9	880-006	SEAL WITH SHIELD	48	2233602	LOCK BAR, REAR - ZINC	83	2302745	SPRING-RELEASE BUTTON
10	188-037	BRUSH ASSEMBLY [2.EA]	49	2152700	SPRING-(LOCKBAR) CAD.PLTD	84	2303720	RELEASE BUTTON-HANDLE
11	725-050	BRUSH RETENTION- PAPER TUBE	50	2262703	SPRING STOP MAXXUM	85	2060408	HANDLE -TOP HALF
12	738-036	BRUSH PLATE W/HOLDER	51	2153602	EYE SHAFT-2LOCKBAR STD PLTD	86	2060415	HANDLE -LOWER HALF
13	975-040	SPRING - TORSION [2.EA]	52	2260506	HINGE-PIN (HEADLESS) ZINC	87	2303412	SCREW- #6-20 X 5/8 SELF TAP [5.EA]
14	337-036	GASKET	53	2293811	YOKE,MAX MNT-POLYPROPYLENE	88	2060005	BEARING-HANDLE PIVOT [2.EA]
15	701-008	O-RING, THRU-BOLT [2.EA]	54	2262607	PIN-CLEVIS ZP MAXXUM BG	89	2064023	SWITCH- FWD REV 5 SP
16	701-081	O-RING	56	2262605	PIN-BWGRD UPPER THREADED ZP	90	2303001	RING- PIG #2
17	830-007	SCREW-8-32 [2.EA]	57	2261722	WASHER- FLAT [2.EA]	92	2060286	CTRL BOX CVR- BLACK
18	830-008	THRU-BOLT 10-32X9.21" [2.EA]	58	2223100	NUT- TENSION 5/16-18 SS [2.EA]	93	2185612	DECAL-COVER MAX70SC/HC
19	990-067	WASHER- STEEL THRUST	59	2260805	CLIP- SPRING ZP MAX BG	96	2033400	SCREW-#10-24 X1-3/4 PPH ZINC
20	990-070	WASHER - NYLATRON [2.EA]	60	2150400	PULL-GRIP	97	2013110	NUT-10-24 HEX
21	2096039	MOTOR ASSEMBLY 12V 3.625 5SPC FW 70#	61	2151700	WASHER-EYE SHAFT .562 OD	98	2263804	STRAP- HOLD DWN 30.5 VELC
23	2032068	TUBE COMPOSITE 52"	■	2991760	BOWGUARD ASSEMBLY-HAND CTRL	■	2994830	BAG ASSEMBLY-MAXXUM
■	1378131	PROPELLER KIT WW2	62	2261976	BRKT BASE TOP	*99	2263431	SCREW 1/4-20 X 3.5 PPH [6.EA]
*24	2091160	PROPELLER (W.WEDGE 2)	63	2991770	BRKT BTM/BEARING FW ASEMBLY	*100	2261713	WASHER-1/4 FLAT S/S [6.EA]
*25	2151726	WASHER-5/16 STD SS	64	2772352	EYELET- KIT	*101	2263103	NUT-1/4-20 NYLOCK-JAM S/S [6.EA]
*26	2053101	NUT-PROP,NYLOC (MED) 5/16 SS	65	2263423	SCREW 5/16-18 X 1 SHCS ZINC	*102	2301720	WASHER-MOUNTING*RUBBER [6.EA]
*27	2092600	PIN-DRIVE (95-4HP'S) SS	66	2263425	SCREW-5/16-18 X 2 1/2 SHCS [2.EA]			
■	2991840	MOUNT, BOW ASSEMBLY W/BOWGRD	68	2261525	SPRING-SLEEVE UPPER			
34	2264241	ARM-UPPER FW,STD	69	2261535	SPRING SLEEVE, LOWER			
35	2293501	BUSHING, STAINLESS STEEL [4.EA]	70	2264702	INSERT-TUBE 2 PER B.MNT			
36	2263500	BOLT, SHOULDER MAXXUM [2.EA]	71	2262704	SPRING, BOWGUARD, HAND CT			
37	2994307	ARM-LOWER ASSEMBLY, STD, FW,	72	2011365	SCREW-COLLAR/NEW KNOB			
38	2263912	MOTOR REST MAXXUM	73	2031520	COLLAR-DEPTH W/O INSERT			
39	2265514	DECAL- MAXXUM MOTOR REST [2.EA]	74	2011365	SCREW-COLLAR/NEW KNOB			

Seal & O-Ring Kit is p/n 2888460

\* This item is part of an assembly. This item cannot be sold separately due to machining and /or assembly that is required. P/N 2184908 REV. C 12-05

