

MAXXUM PRO 80
80 LBS THRUST
24 VOLT 56 AMPS
42" SHAFT

for use with "AI" serial numbers
3-year warranty from the date of purchase

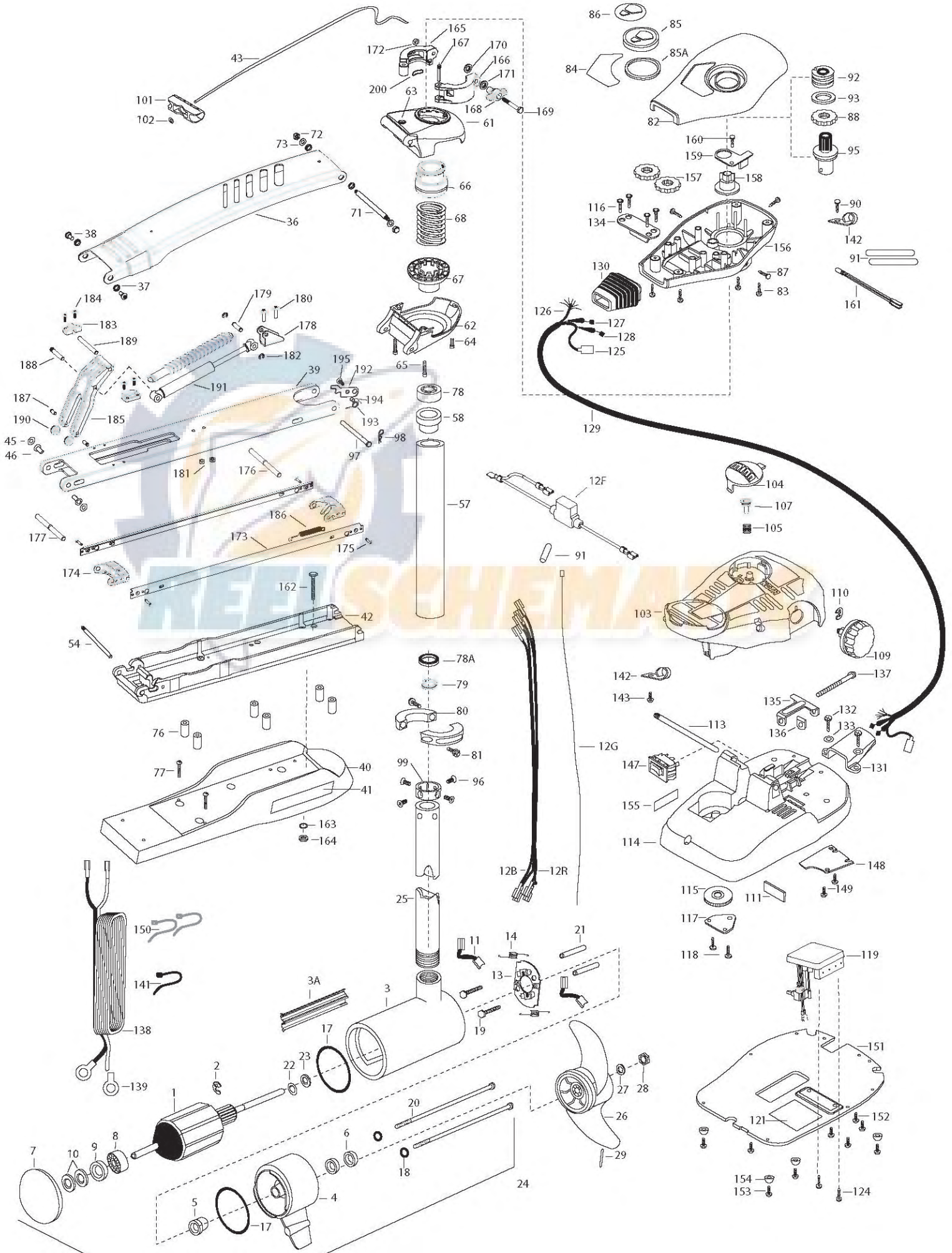

1	2-100-214	ARMATURE ASSEMBLY 24V 4"	71	2262605	PIN- THREADED ZP	137	2263463	SCREW-1/4-20 X 2 STL PPH
2	788-040	RETAINING RING	72	2223100	NUT- NYLOCK [2.EA]	138	2261233	LEADWIRE VARIABLE
3	2-200-160	HOUSING ASSEMBLY CENTER 4.0	73	2261722	WASHER [2.EA]	139	2020700	TERMINAL RING, 3/8 [2.EA]
3A	582-013	CLIP, RETAINING, US2	■	2994832	BAG ASSEMBLY	141	2256300	TIE WRAP-5.5 BLACK
4	2-300-160	BRUSH END HOUSING ASSEMBLY	*76	2261505	SPACER, MOTOR REST [6.EA]	142	2263201	CLAMP WIRE HARNESS MICRO [2.EA]
5	144-017	BEARING- FLANGE (SERVICE ONLY)	*77	2263434	SCREW, 8-18 X 1 PPH SS [2.EA]	143	2332103	SCREW-6-20 X 3/8 THD SS
6	880-025	SEAL [2.EA]	78	2266000	BEARING, BALL-STEEL	147	2254031	SWITCH-MOM/OFF/COM
7	421-276	PLAIN END HOUSING ASSEMBLY	78A	2266116	BEARING, CARTRIDGE	148	2266412	SWITCH PLATE, PT PEDAL
	9421-284	PLAIN END HOUSING ASSEMBLY, US2	79	2266001	BEARING, SPLIT RING	149	2332103	SCREW-6-20 X 3/8 THD SS [2.EA]
8	140-010	BALL BEARING	80	2771617	COLLAR HALF-ZINC-2 PER- KIT	150	2256301	TIE WRAP-5.5 WHITE [2.EA]
9	990-045	THRUST SPACER	81	2263452	SCREW-1/4-20 X 3/4 SHCS SS [2.EA]	151	2264511	BOTTOM PLATE, MAXXUM PT
10	992-010	SPRING WASHER [2.EA]	82	2260283	CONTROL BOX COVER-MAXXUM	152	9953104	SCREW-8 X 1/2 PPH SS [5.EA]
11	186-094	BRUSH [2.EA]	83	2372100	SCREW-8-18 X 5/8 THD [4.EA]	153	2263455	SCREW #12 [4.EA]
12B	640-013	BRUSH LEAD BLK 10 AWG 51-1/2	84	2265641	DECAL COVER, MAXXUM 80	154	2265126	BUMPER [4.EA]
12R	640-117	BRUSH LEAD RED 10 AWG 53		2265648	DECAL COVER, MAXXUM 80-SONAR	155	2266610	DECAL-ON/OFF SWITCH
12G	640-315	GROUND WIRE 42" (US MODELS ONLY)		2265692	DECAL COVER, MAXXUM 80 US2	156	2262535	CONTROL BOX-PLASTIC AT'S
12F	2218200	FUSE HOLDER (US MODELS ONLY)	85	2260150	POINTER DISC TRNSLCNT RED	157	2267800	GEAR-INDICATOR [2.EA]
13	738-004	BRUSH PLATE 4"	85A	2261733	WASHER-FOAM, INDICATOR	158	2262220	INDICATOR-DRIVE
14	975-041	SPRING- TORSION [2.EA]	86	2265800	DECAL-INDICATOR	159	2261905	BRACKET/INDICATOR
17	701-043	O-RING [2.EA]	87	2053414	SCREW-#8-32 X 1/2 TRI-LOBE [3.EA]	160	2301310	SCREW-8-18 X 1/2 SS
18	701-009	O-RING —THRU BOLT [2.EA]	88	2267800	GEAR-INDICATOR	161	2264015	LIGHT/INDICATOR
19	830-027	SCREW -SELF THREAD 10-32X2 [2.EA]	90	2372100	SCREW-8-18 X 5/8 SS	■	2994830	BAG ASSEMBLY-MAXXUM
20	830-094	THRU BOLT 12-24X10.31 [2.EA]	91	2355410	SHRINK TUBE-3/8 OD X 2- [3.EA]	*162	2263431	SCREW 1/4-20 X 3.5 PPH [6.EA]
21	973-025	SPACER- BRUSH PLATE [2.EA]	92	2232360	PULLEY-CABLE DRUM	*163	2261713	WASHER-1/4 FLAT S/S [6.EA]
22	990-051	WASHER- STEEL	93	2261730	WASHER-NYLON	*164	2263103	NUT-1/4-20 NYLOCK-JAM [6.EA]
23	990-052	WASHER- NYLATRON	95	2996247	PINION/RACE ASSEMBLY	■	2991555	CLAMP COLLAR ASSEMBLY
24	2316216	MOTOR ASSEMBLY 24V 4" VARS	96	2223468	SCREW-8-32 X 7/16 ZN PL [4.EA]	165	2071550	CLAMP COLLAR "A"
	2326220	MOTOR ASSEMBLY 24V 4" VARS- SONAR	97	2262607	PIN- CLEVIS ZP	166	2071555	CLAMP COLLAR "B"
25	2032003	TUBE COMP W/4 HOLE 42"	98	2260800	SPRING CLIP SS	167	2072621	PIN-KNURLED
■	1378132	PROPELLER KIT	99	2071560	SPLIT COLLAR	168	2281505	KNOB-CLAMP COLLAR
26	2331160	PROPELLER W.WEDGE 2	101	2150400	PULL-GRIP	170	2071718	WASHER #10 NYLON RETAINING
27	2091701	WASHER-PROP LARGE	102	2151700	WASHER-EYE SHAFT .562 OD	172	2073102	NUT - HEX 1/4 - 28 SS
28	2093101	NUT-PROP NYLOCK SS	103	2994496	FOOT PEDAL/PLUG ASSEMBLY	173	2263610	TIE RAIL SHORT [2 EA.]
29	2262658	PIN-DRIVE SS	104	2993705	PUSH-BUTTON MAGNET ASSEMBLY	174	2262645	LATCH PIN HOLDER [2 EA.]
■	2991739	MOUNT,BOW ASSEMBLY, FW STD W/BG	105	2302732	SPRING-LOWER PEDAL SS	175	2263456	SCREW #8 - 3/4" BTFH SS [4 EA.]
36	2264250	ARM UPPER-FW STD	107	2260810	CLIP, REED SWITCH	176	2262661	LATCH PIN, GROOVED FRONT SS
37	2293501	BUSHING, STAINLESS STEEL [4.EA]	109	2280115	KNOB-SPEED CONTROL VAR	177	2262663	LATCH PIN, GROOVED REAR SS
38	2263500	BOLT, SHOULDER MAXXUM [2.EA]	110	2263000	E-RING TRU-ARC#5133-43	178	2261990	BRACKET, CYLINDER FRONT
■	2774330	LOWER ARM ASSEMBLY,STD,FW,80#	*111	2266413	PLATE -TENSION SCREW FTPED.	179	2262665	PIN, FRONT SHOCK MOUNT
39	2264330	ARM-LOWER ASSEMBLY,STD,FW,EXT	113	2260511	PIN-PIVOT A/T PT PDL	180	2332104	SCREW 1/4-20 X 5/8" PH SS [2 EA.]
40	2263912	MOTOR REST STD MAXXUM	114	2774550	FT PEDAL BASE/PIN ASSEMBLY	181	2073100	1/4-20" NUT SS [2 EA.]
41	2265508	DECAL-MAXXUM,MOTOR REST [2.EA]	115	2262301	PULLEY- FOOT PEDAL	182	2263006	E-CLIP 5/16" SHAFT SS [2 EA.]
42	2773987	BOWPLATE- FW STD MACH/INSERT	116	2223430	SCREW- 8X3/4 PPH TYPE 25 SS [4.EA]	183	2261995	BRACKET-REAR [2 EA.]
43	2251601	ROPE 40" MAXXUM MOUNT	117	2266400	COVER-PULLEY STAMPING	184	2223454	SCREW #10-32 X 1/2" PH SS [4 EA.]
45	2261708	WASHER-3/8X1/2X.016 [2.EA]	118	2301310	SCREW-8-18 X 1/2 SS [2.EA]	185	2261545	YOKE-GAS ASSIST
46	2267318	BEARING NYLINER- [2.EA]	119	2264054	CONTROL BOARD ASSEMBLY 24-36V MAX	186	2262722	SPRING EXTENSION
54	2260506	HINGE-PIN HEADLESS ZINC	121	2365107	INSULATING PAD 2.3 X 3.2	187	2262635	PIN ROLLER SS [2 EA.]
■	2772085	TUBE W/BEARING RACE ASSEMBLY 42"	124	2223455	SCREW, 10-32 X 1/2 [2.EA]	188	2262667	PIN-KNURLED SS
57	2272085	TUBE -OUTER 21" 4 HOLES [FOR 42"]	125	2211410	EXTENSION CABLE- US2	189	2262669	PIN-YOKE PIVOT SS
58	2266260	BEARING RACE-(565T)	126	2261220	WIRE HARNESS AT & MAX 82.5	190	2262320	ROLLER YOKE [2 EA.]
			127	2267505	CABLE ASSEMBLY-RIGHT 5'	191	2998432	CYLINDER/SHOCK BOOT ASSEMBLY
■	2991762	BOWGUARD ASSEMBLY-FT CTRL,MAX	128	2267515	CABLE ASSEMBLY-LEFT 5'	192	2262670	LATCH PIN STOP LEVER
61	2772319	BRACKET BASE TOP/EYELETASSEMBLY	129	2265430	CABLE JACKET 5'	193	2262723	SPRING, MAXXUM PRO
62	2991771	BRKT BOTTOM/BEARING FW ASSEMBLY	130	2265110	BOOT-CONTROL BOX	194	2301700	SPACER-RELEASE LEVER BRASS
63	2262315	EYELET KIT -ROPE	131	2265115	BOOT-FOOT PEDAL BASE	195	2332104	SCREW 1/4-20 X 5/8" SS
64	2263423	SCREW 5/16-18 X 1" SHCS	132	2372100	SCREW-8-18 X 5/8 THD SS [2.EA]	200	2075120	URETHANE PAD
65	2263425	SCREW-5-16/18 X 2-1/2 SHCS [2.EA]	133	2261714	WASHER-MAXXUM PT PDL [2.EA]			
66	2071541	SPRING-SLEEVE UPPER	134	2261901	BRACKET-CONDUIT AT/MAX			
67	2071535	SPRING SLEEVE, LOWER	135	2263210	BRACKET-CONDUIT ADJUSTMENT			
68	2262712	SPRING, BOWGUARD, NIK PL	136	2263140	NYLOCK KEEPER			

2889460 seal & oring kit

Max 80 is 24-volts only!!!

OPTIONAL BROWN WIRE FOR SONAR EQUIPPED MOTORS.
SEE BOAT WIRING DIAGRAM
FIL MARRON OPTIONNEL POUR MOTEURS
ÉQUIPÉS DE SONAR. VOYEZ LE SCHEMA DE CÂBLAGE DU BATEAU.

