

Riptide 55 SP/CP
55 LBS THRUST
12 VOLT 50 AMP
48" SHAFT

for use with "AI" serial numbers
3-year warranty from the date of purchase

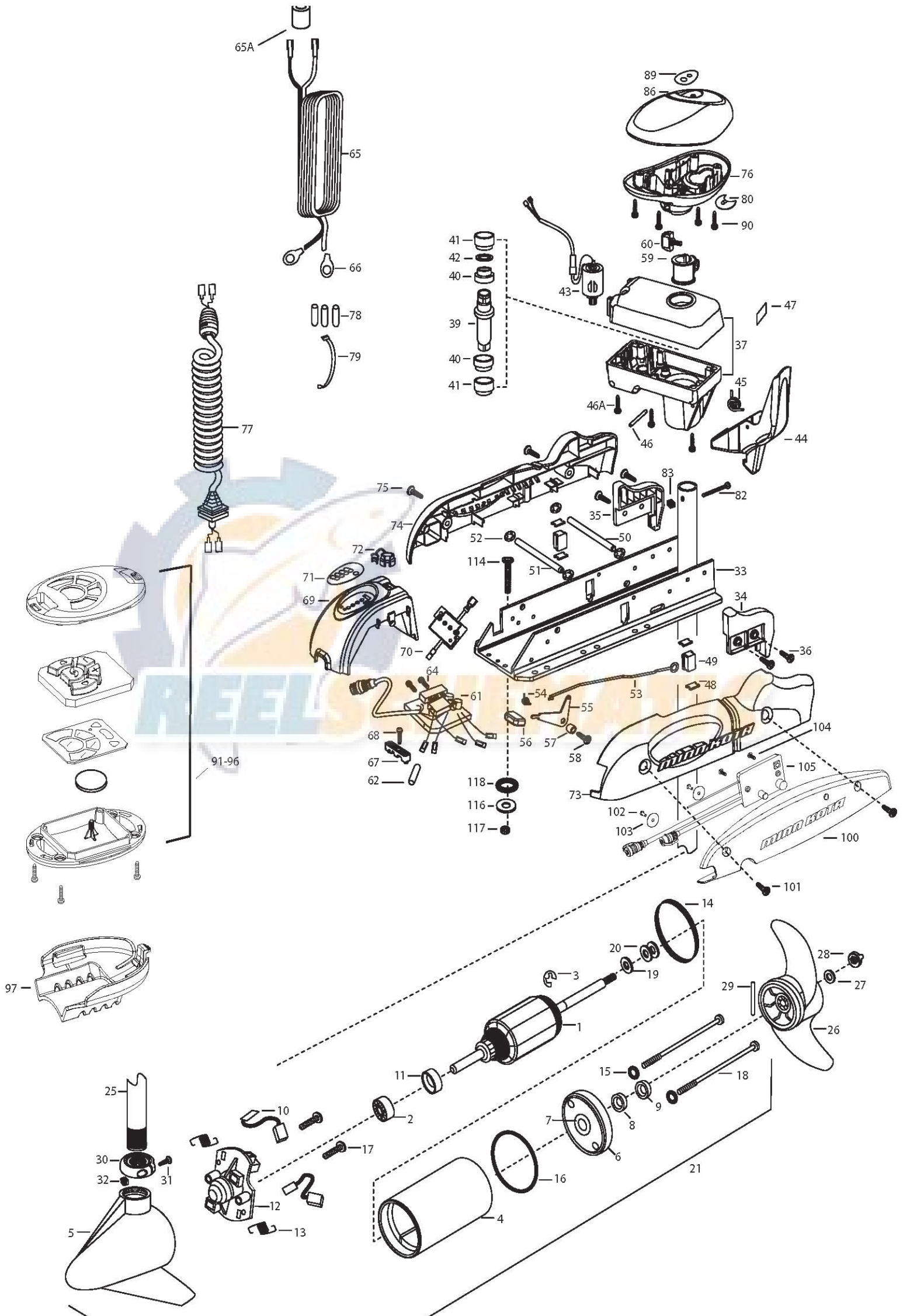

1	2-100-115	ARMATURE ASSEMBLY 12V VARS TXT	*42	2304603	O-RING	82	2332102	SCREW-10-24 X 1-3/4
2	140-010	BALL BEARING	43	2307050	MOTOR- DRIVE HOUSING HIGH SPD	83	2333101	NUT-HEX 10-24 NYLOC
3	788-015	RETAINING RING	44	2307201	LATCH HANDLE PD/AP	86	2300243	CONTROL BOX COVER- RIPTIDE WHITE
4	2-200-301	HOUSING ASSEMBLY CENTER 3.62 TXT	45	2302750	SPRING- LATCH TORSION PD/AP	89	2315689	DECAL- COVER 55pd
5	421-336	HOUSING -BRUSH END 3.62 TXT	46	2302628	PIN- ROLL 3/16X2 SS	90	2012100	SCREW-8-18 X 5/8 THD CUT [4.EA]
6	2-400-337	PLAIN END HOUSING ASSEMBLY 3.625	46A	2303405	SCREW - DRIVE HOUSING [6 EA]			
7	144-049	BEARING - FLANGE (SERVICE ONLY)	47	2305564	DECAL-STOW/DEPLOY	■	2994020	COPILOT TRANSMITTER
8	880-003	SEAL	48	2335110	PAD-PIVOT SUPT [4.EA]	91		CASE, COVER, TRANSMITTER
9	880-006	SEAL WITH SHIELD	49	2305103	PIVOT PAD- NEW MTR'L [2.EA]	92		KEYPAD
10	188-036	BRUSH ASSEMBLY [2.EA]	50	2330510	PIN-LATCH PD BASE SS	93		CIRCUIT BOARD, TRANSMITTER
11	725-050	BRUSH RETENTION- PAPER TUBE	51	2330520	PIN-PIVOT PD BASE SS	94		BATTERY, COIN
12	738-036	BRUSH PLATE W/HOLDER	52	2333100	NUT-SPEED [4.EA]	95		CASE, BOTTOM, TRANSMITTER
13	975-040	SPRING - TORSION [2.EA]	53	2303612	ROD-RELEASE RT/AP S	96		SCREW, TRANSMITTER [4EA]
14	337-036	GASKET	54	2322700	SPRING-RELEASE LEVER	97	2371990	ROD MOUNT
15	701-008	O-RING, THRU-BOLT [2.EA]	55	2333705	LEVER-RELEASE SS	■	2994089	RECEIVER ASSEMBLY V2, COPILOT
16	701-081	O-RING	56	2300101	RELEASE-KNOB	100	2372511	CASE, RECEIVER WHT
17	830-007	SCREW-8-32 [2.EA]	57	2301700	SPACER-RELEASE LEVER	101	2373442	SCREW 1/4-20 X 1.75 SS [2EA]
18	830-042	THRU-BOLT 10-32X8.83 [2.EA]	58	2332104	SCREW-1/4-20 X 5/8 SS	102	2373450	SCREW #8 X 3/8 [2EA]
19	990-067	WASHER- STEEL THRUST	59	2031522	COLLAR- DRIVE (W/INSERT)	103	2371727	WASHER [2EA]
20	990-070	WASHER - NYLATRON [2.EA]	60	2011366	SCREW-COLLAR/NEW KNOB SS	104	2373418	SCREW #8 X 5/8 SS
21	2097095	MOTOR ASSEMBLY 12V 3.62 48"	61	2304055	CONTROL BOARD ASSEMBLY- 12V PD	105	2374089	CIRCUIT BOARD V2, RECEIVER
25	2032021	TUBE-CARBON COMPOSITE WHT 48"	62	2355410	SHRINK TUBE-3/8 ODX2	■	2994864	BAG ASSEMBLY- (BOLT,NUT,WASHERS)
■	1378131	PROPELLER KIT	64	2303434	SCREW-8-32 X 5/8 [3.EA]	*114	2263462	BOLT-MOUNTING-1/4X2 W/STG [6.EA]
26	2091160	PROPELLER W/WEDGE 2	65	2090651	LEADWIRE IOGA 44"	*116	2261713	WASHER-1/4 [6.EA]
27	2151726	WASHER-5/16 SS	65A	2307310	BEAD - FERRITE (CE MODELS ONLY)	*117	2263103	NUT NYLOK 1/4-20 MTG [6.EA]
28	2198400	ANODE- ZINC 3.25/3.625 LWR U	66	2020700	TERMINAL RING [2.EA]	*118	2301720	WASHER-MOUNTING RUBBER [6.EA]
29	2092600	PIN-DRIVE	67	2321310	STRAIN RELIEF- BRACKET PD/AP			
30	2301545	COLLAR- LATCH PD/AP	68	2323405	SCREW-1/4-20 X 5/8 SS			
31	2303434	SCREW- 8-32X5/8 MACH PHCR	69	2306556	HOUSING- CENTER PD/AP WHIT			
32	2303112	NUT 8-32 NYLOC SS	70	2074080	BATTERY GAUGE - 12 VOLT			
33	2301935	EXTRUSION- BASE MACHINED	71	2316606	DECAL- BATT GAUGE H RT AP			
34	2303932	MOTOR REST- RIGHT 3-5/8	72	2302935	STRAIN RELIEF-DR. HOUSING			
35	2303937	MOTOR REST- LEFT 3-5/8	73	2303944	SIDEPLATE (RIGHT) WHITE			
36	2332104	SCREW 1/4-20X5/8 SS SELF TAP [4.EA]	74	2303949	SIDEPLATE(LEFT) WHITE			
37	2771827	DRIVE HOUSING / LATCH HANDLE WHITE	75	2332104	SCREW-1/4-20 X 5/8 SS			
■	2882011	BUSHING/ OUTSHAFT KIT (INCLUDES 39-42)	76	2302516	CONTROL BOX WHT			
			77	2991280	COIL CORD WSTRAIN RELIEF 48, 54"			
*39	2302010	DRIVE HOUSING OUTPUT SHAFT	78	2065400	WIRE INSULATOR-LGE 1-3/4 [3.EA]		2888460	seal & oring kit
*40	2307304	BUSHING- INNER [2.EA]	79	2256300	TIE WRAP-5" BLACK			
*41	2307305	BUSHING- OUTER [2.EA]	80	2224703	INSERT- PLUG WHITE			

RT55SP is 12-volt!

