

50PD
50 LBS THRUST
12 VOLT 42 AMPS
54" OR 48" SHAFT

for use with "K" serial numbers
2-year warranty from the date of purchase

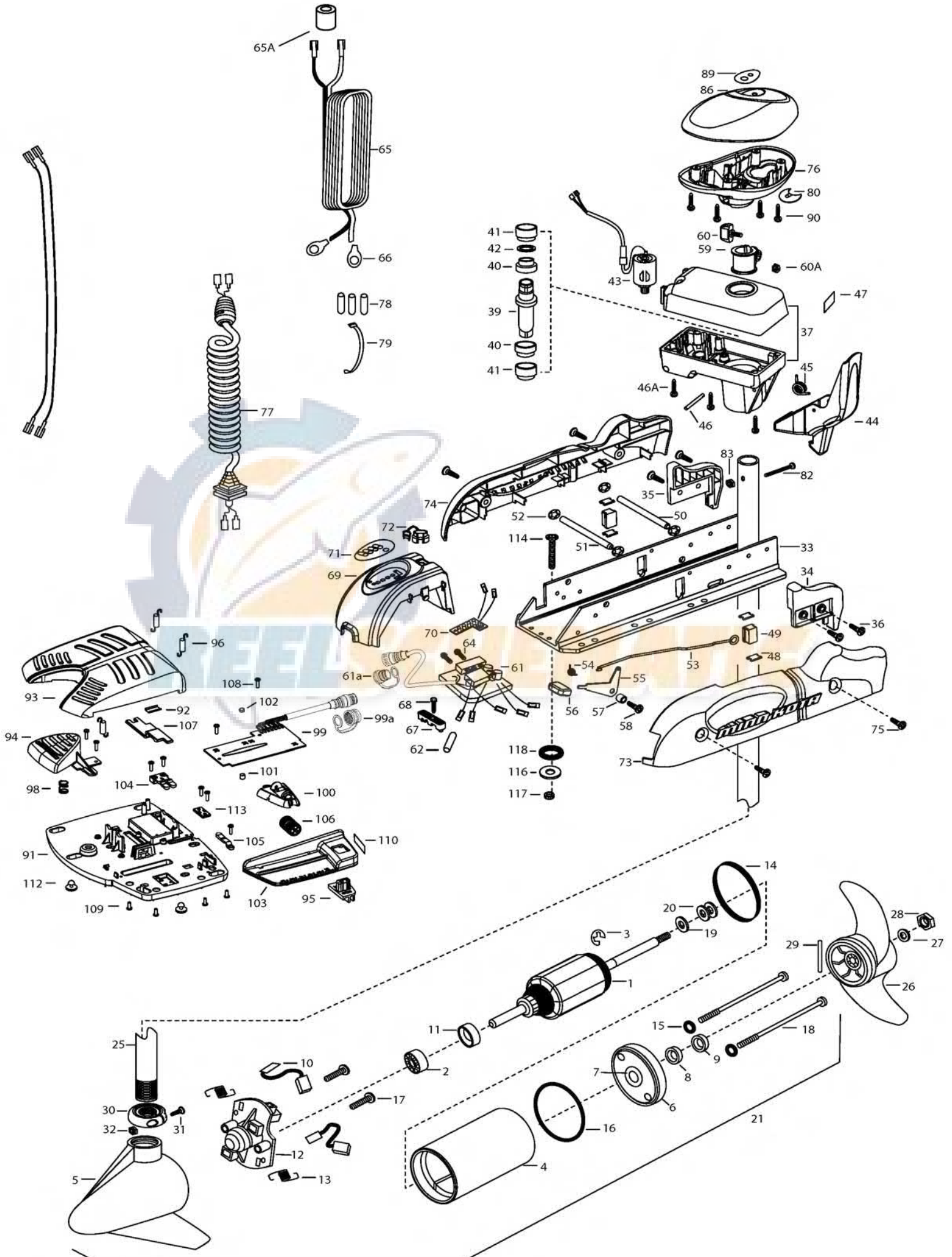

1	2-100-118	ARMATURE ASSEMBLY 12V VARS TXT	*40	2307304	BUSHING- INNER [2.EA]	77	2991280	COIL CORD WSTRAIN RELIEF 48, 54"
2	140-010	BALL BEARING	*41	2307305	BUSHING- OUTER [2.EA]		2991282	COIL CORD WSTRAIN RELIEF 60"
3	788-015	RETAINING RING	*42	2304603	O-RING	78	2065400	WIRE INSULATOR-LGE 1-3/4 [3.EA]
4	2-200-101	HOUSING ASSEMBLY CENTER 3.62 TXT	43	2307050	MOTOR- DRIVE HOUSING HIGH SPD	79	2256300	TIE WRAP-5" BLACK
5	421-065	HOUSING -BRUSH END 3.62 TXT	44	2307201	LATCH HANDLE PD/AP	80	2224702	INSERT- PLUG
6	2-400-101	PLAIN END HOUSING ASSEMBLY 3.625	45	2302750	SPRING- LATCH TORSION PD/AP		2224700	INSERT- PLUG US2
7	144-049	BEARING - FLANGE (SERVICE ONLY)	46	2302627	PIN- ROLL ZINC			
8	880-003	SEAL	46A	2303407	SCREW - DRIVE HOUSING [6 EA]	82	2033400	SCREW-10-24 X 1-3/4 PPH Z/P
9	880-006	SEAL WITH SHIELD	47	2305564	DECAL-STOW/DEPLOY	83	2013110	NUT-HEX 10-24 ZCP
10	188-036	BRUSH ASSEMBLY [2.EA]	48	2305110	PAD-PIVOT SUPT [4.EA]	86	2300237	CONTROL BOX COVER- POWERDRIVE
11	725-050	BRUSH RETENTION- PAPER TUBE	49	2305103	PIVOT PAD- NEW MTR'L [2.EA]	89	2315681	DECAL- COVER 50PD
12	738-036	BRUSH PLATE W/HOLDER	50	2300500	PIN-LATCH	90	2012100	SCREW-8-18 X 5/8 THD CUT [4.EA]
13	975-040	SPRING - TORSION [2.EA]	51	2300510	PIN-PIVOT	■	2994725	FOOT PEDAL ASSEMBLY
14	337-036	GASKET	52	2013100	NUT-SPEED [4.EA]	91	2304505	FOOT PEDAL BASE
15	701-008	O-RING, THRU-BOLT [2.EA]	53	2303612	ROD-RELEASE RT/AP S	92	2308501	WEAR PLATE FOOT PDL
16	701-081	O-RING	54	2322700	SPRING-RELEASE LEVER	93	2300255	FOOT PEDAL, CORDED UPPER
17	830-007	SCREW-8-32 [2.EA]	55	2303710	LEVER-RELEASE	94	2303723	BUTTON, MOMENTARY
18	830-042	THRU-BOLT 10-32X8.83 [2.EA]	56	2300101	RELEASE-KNOB	95	2303722	BUTTON, MOM/CON
19	990-067	WASHER- STEEL THRUST	57	2301700	SPACER-RELEASE LEVER	96	2302730	SPRING-LONG-UPPER PEDAL [3.EA]
20	990-070	WASHER - NYLATRON [2.EA]	58	2303430	SCREW-1/4-20 X 5/8	98	2302732	SPRING-LOWER PEDAL
21	2097094	MOTOR ASSEMBLY 12V 3.62 48"	59	2031522	COLLAR- DRIVE (W/INSERT)	99	2304052	CONTROL BOARD ASSEMBLY-FT PDL
	2097090	MOTOR ASSEMBLY 12V 3.62 54"	60	2011365	SCREW-COLLAR/NEW KNOB	99A	2320207	DUST CAP
25	2032076	TUBE-CARBON COMPOSITE 54"	60A	2323104	NUT	100	2308620	SLIDER, SPEED
	2032075	TUBE-CARBON COMPOSITE 48"	61	2304060	CONTROL BOARD ASSEMBLY- 12V PD	101	2308409	MAGNET, 1/4 X 1/4
■	1378131	PROPELLER KIT	61A	2320208	DUST PLUG	102	2778408	MAGNET, 1/4 X 1/8
26	2091160	PROPELLER W/WEDGE 2	62	2355410	SHRINK TUBE-3/8 ODX2	103	2300252	COVER, SPEED SELECTOR
27	2151726	WASHER-5/16 SS	64	2303434	SCREW-8-32 X 5/8 [3.EA]	104	2308606	SWITCH, DOUBLE FINGER
28	2053101	NUT-PROP NYLOC	65	2090651	LEADWIRE IOGA 44"	105	2308608	SWITCH, SINGLE FINGER
29	2092600	PIN-DRIVE	65A	2307310	BEAD - FERRITE (CE MODELS ONLY)	106	2307900	WHEEL, SPEED
30	2301545	COLLAR- LATCH PD/AP	66	2020700	TERMINAL RING [2.EA]	107	2308625	SLIDER, STEERING
31	2303434	SCREW- 8-32X5/8 MACH PHCR	67	2321310	STRAIN RELIEF- BRACKET PD/AP	108	2302100	SCREW-6-20 X 1/2 [9.EA]
32	2303112	NUT 8-32 NYLOC SS	68	2323405	SCREW-1/4-20 X 5/8	109	2372103	SCREW-6.20 X 3/8 [4.EA]
33	2301936	EXTRUSION- BASE MACHINED	69	2306555	HOUSING- CENTER PD/AP	110	2316600	DECAL, ON/OFF SWITCH
34	2303932	MOTOR REST- RIGHT 3-5/8	70	2074070	BATTERY GAUGE - 12 VOLT	112	2994859	BAG ASSEMBLY- 5 RUBBER BUMPERS
35	2303937	MOTOR REST- LEFT 3-5/8	71	2316605	DECAL, BATTERY GAUGE	113	2302907	STRN RLF PD FP
36	2303430	SCREW 1/4-20X5/8 SELF TAP [4.EA]	72	2302935	STRAIN RELIEF-DR. HOUSING	■	2994864	BAG ASSEMBLY- (BOLT,NUT,WASHERS)
37	2771826	DRIVE HOUSING / LATCH HANDLE ASSY	73	2303960	SIDEPLATE (RIGHT)PD MK	*114	2263462	BOLT-MOUNTING-1/4X2 W/STG [6.EA]
■	2882011	BUSHING/ OUTSHAFT KIT (INCLUDES 39-42)	74	2303965	SIDEPLATE(LEFT)PD MK	*116	2261713	WASHER-1/4 [6.EA]
			75	2303430	SCREW-1/4-20 X 5/8- [4.EA]	*117	2263103	NUT NYLOK 1/4-20 MTG [6.EA]
*39	2302010	DRIVE HOUSING OUTPUT SHAFT	76	2302515	CONTROL BOX PD/AP	*118	2301720	WASHER-MOUNTING RUBBER [6.EA]
						■	2888460	SEAL & ORING KIT

* This item is part of an assembly. This item cannot be sold separately due to machining and /or assembly that is required.

P/N 2314947

REV. O ECN 31553

6-09

12-24 VOLT MODELS MODÈLES 12-24 V

PowerDrive 50 is 12-volt only!

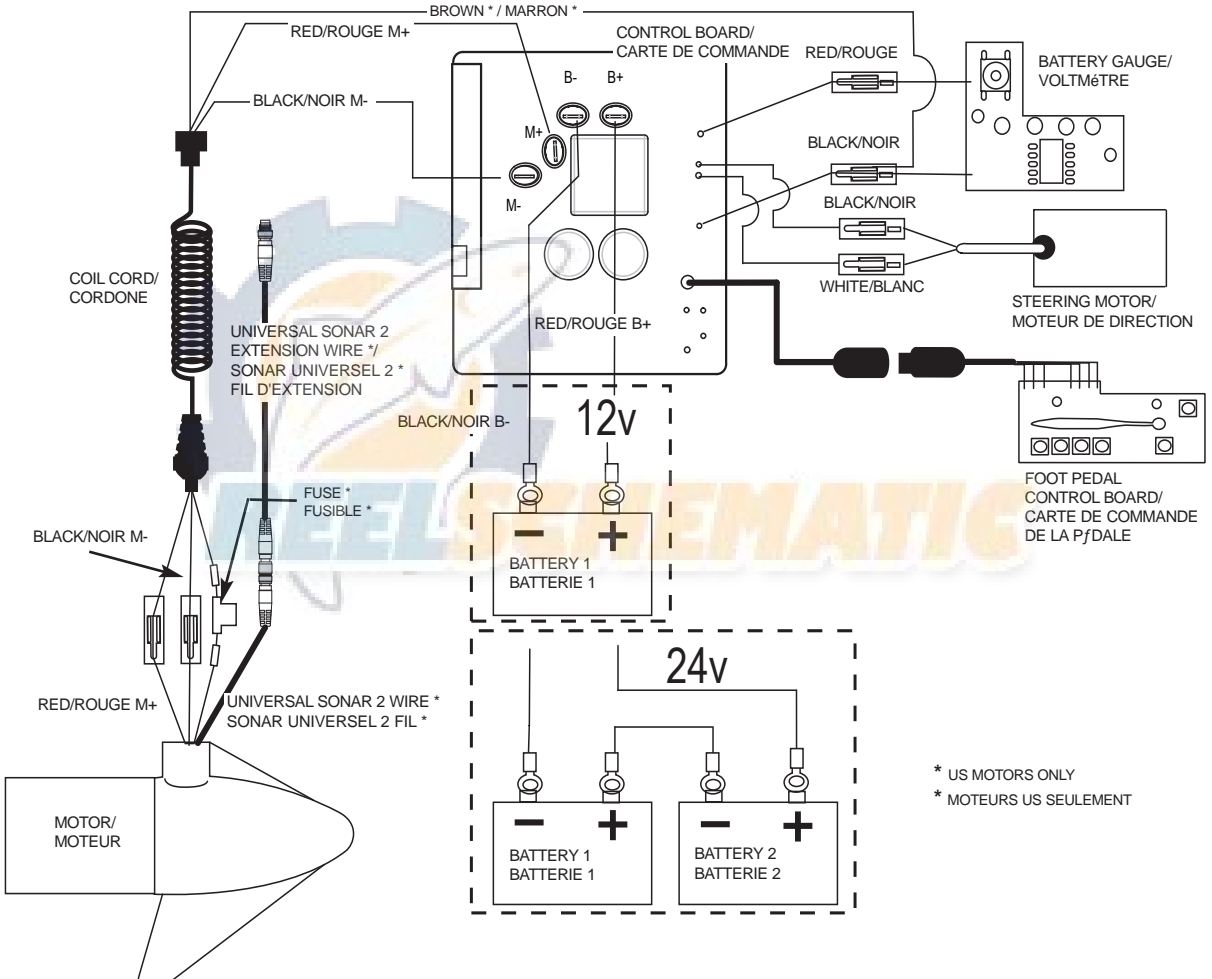

* US MOTORS ONLY
* MOTEURS US SEULEMENT