

TERROVA 80
80 LBS THRUST
24 VOLT 56 AMPS
45", 54" OR 60" SHAFT

for use with "L" serial numbers
2-year warranty

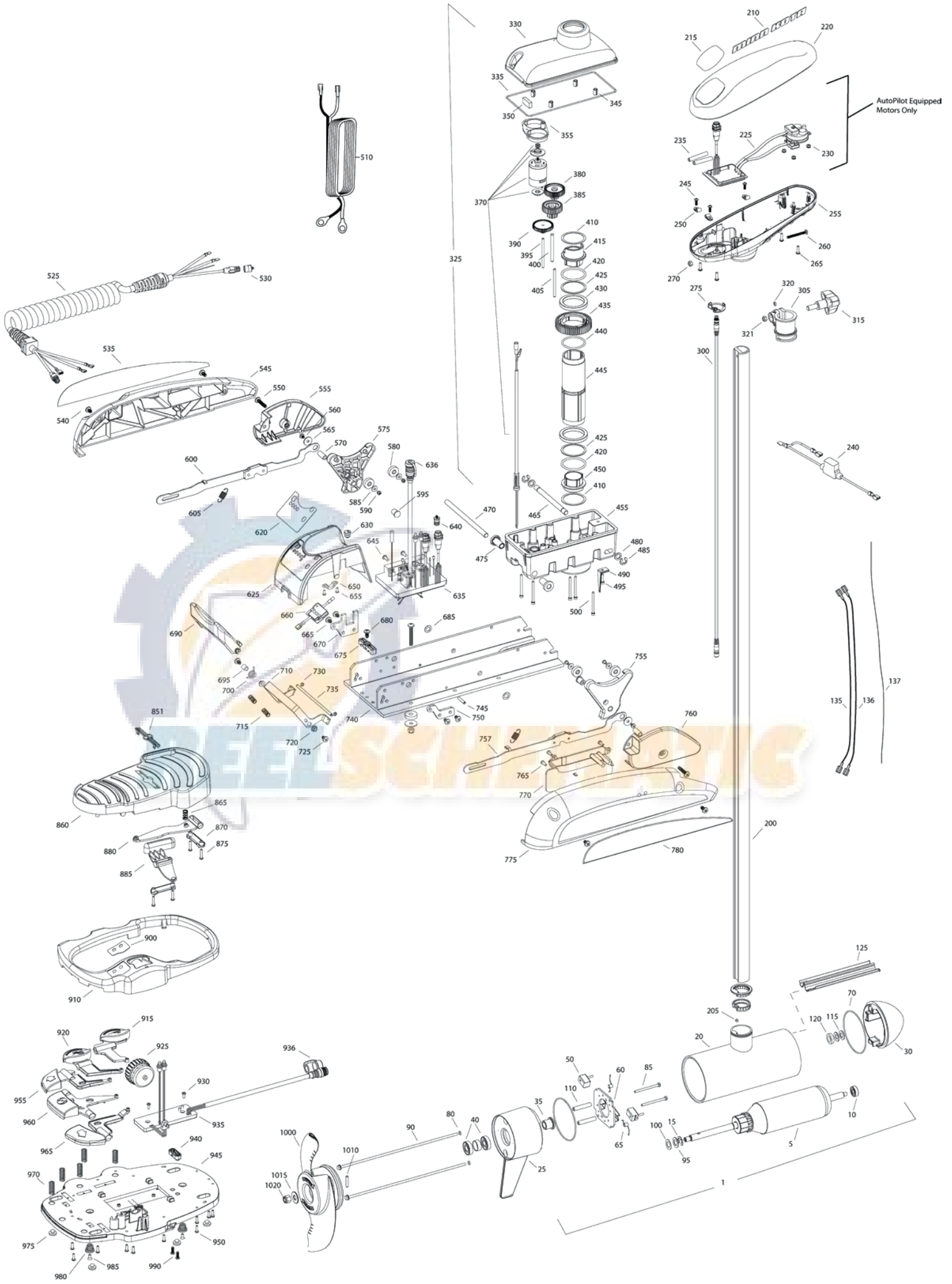

In the U.S.A., replacement parts may be ordered directly from MINN KOTA Parts Dept., 121 Power Drive, P.O. Box 8129 Mankato, Minnesota 56002-8129. In Canada, parts may be ordered from any of the Canadian Authorized Service Centers shown on the enclosed list. Be sure to provide the MODEL and SERIAL numbers of your motor when ordering parts. Please use the correct part numbers from the parts list. Payment for any parts ordered from the MINN KOTA parts department, may be by cash, personal check, Discover Card, MasterCard or VISA. To order, call 1-800-227-6433 or FAX 1-800-527-4464.

Fuera de los Estados Unidos, consultar la lista anexa para ubicar el Centro de servicio autorizado MINN KOTA. No dejar de incluir el número del MODELO y el número de SERIE del motor para el cual se solicitan las piezas. Usar siempre los números de pieza correctos indicados en la lista de piezas.

Item	P/N	Description	Qty	Item	P/N	Description	Qty	Item	P/N	Description	Qty	Item	P/N	Description	Qty
1	2777002	24V Motor 60" FW	1	300	2211415	Universal sonar 2 extension cable	1	595	2324705	Insert, ramp	2	936	2320207	Dust cap	1
	2777001	24V Motor 54" FW	1	305	2771500	Depth collar assembly	1	600	2994202	Arm, release, left	1	940	2322900	Strain relief, foot pedal	1
	2777000	24V Motor 45" FW	1	315	2260906	Knob (included in #305)	1	605	2322710	Spring, extension	2	945	2324500	Base plate, foot pedal	1
	2777004	24V Motor US2 60"	1	320	2321706	Washer (included in #305)	1	■	2770250	Cover, speed control with decal	1	950	2301310	Screw, #8 x .5	10
	2777003	24V Motor US2 54"	1	321	2323102	Nut (included in #305)	1	620	2325650	Decal, speed control	1	955	2323700	Button, steer, left	1
	2777005	24V Motor US2 45"	1	325	2997020	Steering housing	1	625	2320210	Cover, speed control	1	960	2323705	Button, momentary	1
5	2-100-214	Armature assembly	1	330	2326501	Steering housing top	1	630	2322901	Strain relief	1	965	2323701	Button, steer, right	1
10	140-010	Bearing	1	335	2324604	O-ring, case seal	1	635	2324012	Control board, 24-36v	1	970	2322704	Spring, foot pedal	5
15	788-040	Retaining ring	1	345	2305605	Roll pin 5/16	4	■	2884050	Switch-reed repair kit	1	975	2994859	Bumper, bag assy	1
20		Included in #200 assembly		350	2308601	Breather, filter	1	636	2320208	Dust plug	1	980	2322706	Spring, barrel	2
25	2-300-170	Brush end housing assembly	1	355	2328610	Cradle, motor	1	640	2320203	Cap, dust, control board	1	985	2323420	Screw, 8-18 x .375	2
30	421-276	Plain end housing assembly STD	1	370	2777020	Motor, steering assembly	1	645	2323406	Screw, 10-24 x	2	990	2372100	Screw, 8-18 x .625	2
	9421-286	Plain end housing US2 60"	1	380	2302255	Gear, cluster 3rd stage	1	650	2321315	Holder, connector	1				
	9421-285	Plain end housing US2 54"	1	385	2302250	Gear, cluster 2nd stage	1	655	2332103	Screw, 6-20 x .375	2	■	1378132	Propeller kit WW2	
	9421-284	Plain end housing US2 45"	1	390	2302245	Gear, cluster 1st stage	1	660	2074071	Battery meter, 24v	1	■	2994876	Propeller bag assy	
35	144-017	Flange bearing	1	395	2302610	Shaft, gear 1st stage	1	665	2323402	Screw, 1/4-20 x .375	4	1000	2331160	Propeller WW2	1
40	880-025	Seal	2	400	2302620	Shaft, gear 3rd stage	1	670	2321940	Bracket, strain relief	1	1010	2262658	Drive pin, large	1
50	188-094	Brush	2	405	2302615	Shaft, gear 2nd stage	1	675	2321310	Strain relief, wire	1	1015	2091701	Washer, prop, large	1
60	2-600-199	Brush plate assembly	1	410	2321704	Washer, thrust	2	680	2323405	Screw, 1/4-20 x .5	1	1020	2093101	Nut, nylock, prop, large	1
65	975-041	Brush spring	2	415	2321515	Liner, output tube	1	685	2013100	Speed nut, .375	2				
70	701-043	O-ring, motor	2	420	2324608	O-ring, 224	2	690	2320215	Handle, release cover	1	■	2994864	Mounting hardware bag assy	
80	701-009	O-ring, thru-bolt	2	425	2321720	Shim, O-ring	2	695	2301700	Bushing,	1				
85	830-027	Screw, 10-32 x 2	2	430	2327308	Bearing, ball sealed	2	700	2322701	Spring, release handle	1	■	2889460	Seal & Oring Kit	
90	830-094	Thru-bolt	2	435	2322200	Gear, output	1	710	2320400	Handle, release FW	1				
	830-095	Thru-bolt, Sonar only	2	440	2324601	O-ring, output gear	1	715	2322712	Spring, release handle	2				
95	990-051	Washer, steel	2	445	2322030	Tube, output machined	1	720	2322604	Bushing, handle	2				
100	990-052	Washer, nylatron	2	450	2321510	Collar, drive, bottom	1	725	2332104	Screw, 1/4-20 x .625	2				
110	973-025	Spacer, brush plate	2	455	2326506	Steering housing, Bottom	1	730	2323000	E-clip, 3/16, SS	2				
115	992-010	Washer, Belleville	2	465	2322600	Pin, latch, zp	1	735	2322606	Pin, follower, handle	1				
120	990-045	Spacer, thrust	1	470	2322602	Pin, pivot, zp	1	740	2321901	Base extrusion, machined	1				
125	582-013	Clip, retaining, short	1	475	2327310	Bushing, pivot pin	2	745	2322912	Spring pin,	2				
135	640-025	Leadwire, black	1	480	2321702	Washer, flat .375	2	750	2321950	Bracket, sideplate	1				
136	640-133	Leadwire, red	1	485	2263011	E-ring .375	2	755	2323900	Ramp, 4" right	1				
137	640-317	Groundwire, brown, US2 only	1	490	2322702	Spring, latch pin	2	757	2994204	Arm, release, Right	1				
200	2777096	Tube, composite 60" FW	1	495	2323410	Screw, 8-32 x .75	1	760	2321920	Skid, right	1				
205		Included in #200 assembly		500	2323408	Screw, 8-32 x 2	7	765	2301310	Screw, 8-18 x .5	3				
210	2325665	Decal, cover	2	510	2090651	Leawire, 10 ga	1	770	2320220	Cover, access, FW	1				
215	2325674	Decal, ctrl box 80	1	525	2991273	Coil cord, 45"	1	775	2321910	Sideplate, right	1				
	2325675	Decal, ctrl box 80 US2	1		2991271	Coil cord, 54"	1	780	2325640	Decal, sideplate, right	1				
	2325676	Decal, ctrl box 80 Autopilot	1		2991274	Coil cord, US2, 45"	1	850	2994720	Foot pedal	1				
	2325677	Decal, ctrl box 80 Autopilot & US2	1		2991272	Coil cord, US2, 54"	1	851	2326710	Plug, foot pedal	1				
220	2320200	Cover, ctrl box	1	530	2320202	Cap, dust, coil cord, non-AP only	1	860	2324400	Pedal, heel-toe	1				
225	2324030	Ctrl board, compass, Autpilot only	1	535	2325641	Decal, sideplate, left	1	865	2322714	Spring, momentary	1				
230	2302960	Grommet, compass, Autopilot only	3	540	2323404	Screw, 1/4-20	4	870	2321300	Clamp	2				
235	2065400	Wire insulator	2	545	2321915	Sideplate, left	1	875	2223430	Screw, 8 x .75	4				
240	2218200	Fuse holder, US2 only	1	550	2323403	Screw, 1/4-20 x .375	2	880	2328600	Flex finger	1				
245	2372100	Screw, 8-18 x .625	3	555	2321925	Skid, left	1	885	2323710	Button, momentary, left	1				
250	2052510	Cable clamp	3	560	2323422	Screw, 10-24 x .375	2	900	2325660	Decal, foot pedal	1				
255	2322500	Ctrl box	1	565	2321700	Washer, #10 SS	2	910	2320205	Cover, heel-toe	1				
260	2332102	Screw, 10-24	1	570	2323500	Bolt, shoulder	2	915	2323725	Button, AP	1				
265	2372100	Screw, 8-18 x .625	4	575	2323905	Ramp, 4" left	1	920	2323715	Button, Mom/Con	1				
270	2333101	Nut, 10-24	1	580	2325115	Pad, rubber rest	4	925	2320100	Knob, speed, foot pedal	1				
275	2224700	Plug, ctrl box, US2 motors only	1	585	2321706	Washer, #8	4	930	2332103	Screw, 6-20 x .375	2				
	2224702	Plug, ctrl box	1	590	2323412	Screw, 8-18 x .25	4	935	2324020	Control board, foot pedal	1				

* This item is part of an assembly. This item cannot be sold separately due to machining and/or assembly that is required.

P/N 2324931

REV. W 31552 8-09

Terrova 80 is 24-v only!

THIS IS A UNIVERSAL MULTI-VOLTAGE DIAGRAM. DOUBLE CHECK YOUR MOTORS VOLTAGE FOR PROPER CONNECTIONS
CECI EST UN SCHEMA À TENSION MULTIPLE UNIVERSEL. REVÉRIFIEZ LA TENSION DE VOTRE MOTEUR POUR BIEN LE BRANCHER.

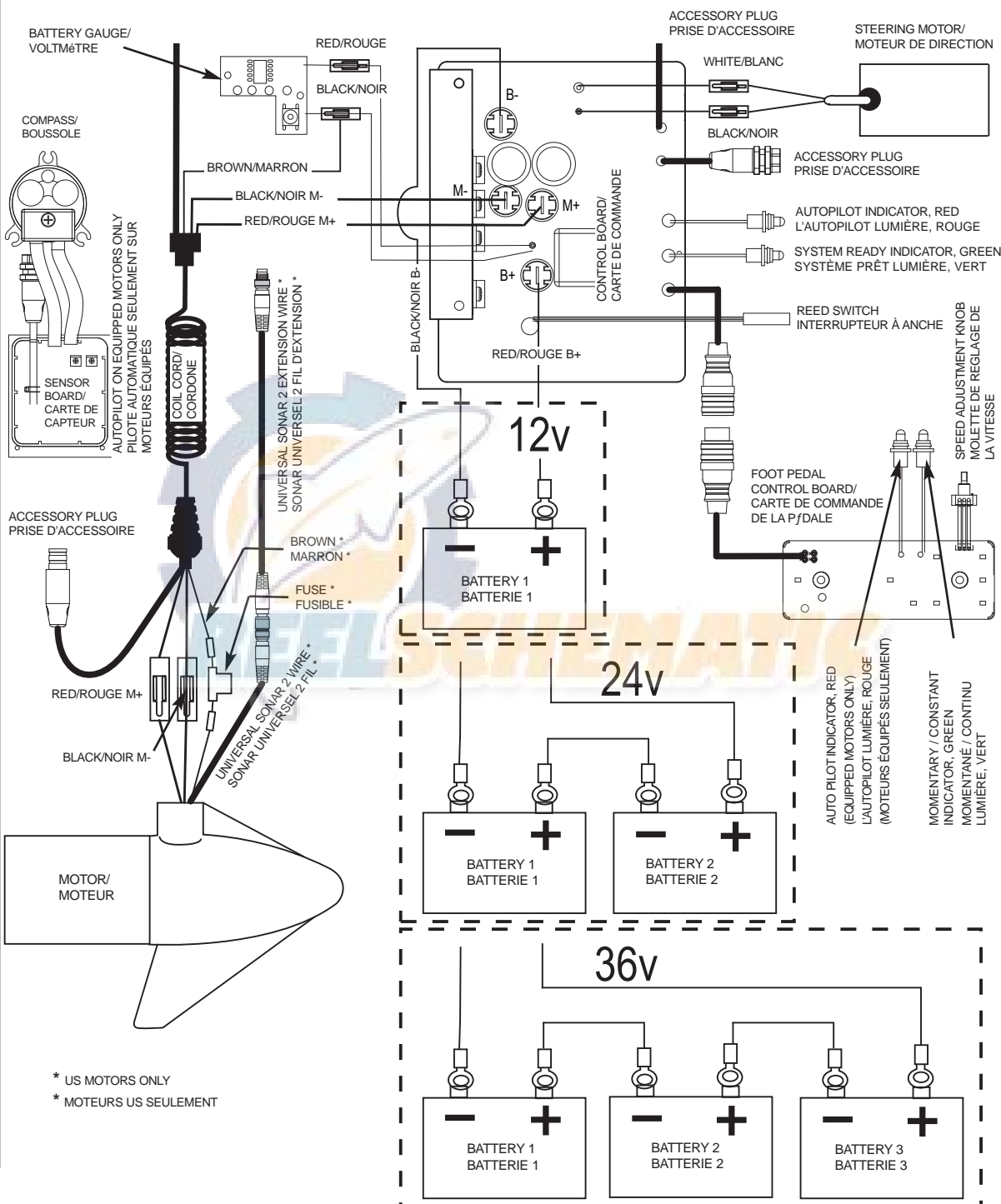

* US MOTORS ONLY
 * MOTEURS US SEULEMENT