

ENDURA MAX 45 PARTS DIAGRAM

for use with "N" serial numbers

2-year warranty

12-volt 42 amps

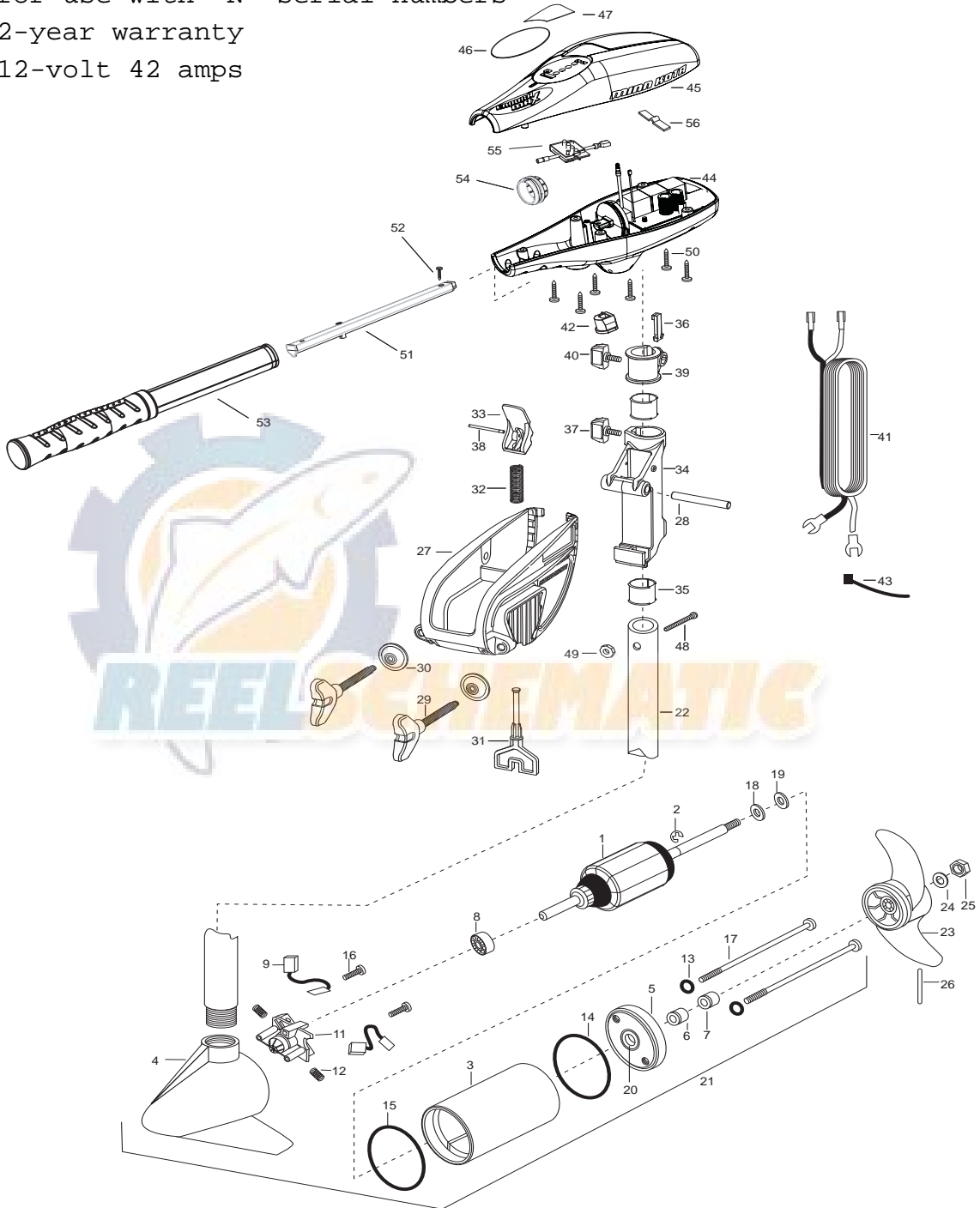

ENDURA MAX 45 36" PARTS LIST

In the U.S.A., replacement parts may be ordered directly from MINN KOTA Parts Dept., 121 Power Dr., Mankato, MN 56002-8129. In Canada, parts may be ordered from any of the Canadian Authorized Service Centers. Visit minnkotamotors.com for a current listing. Be sure to provide the MODEL and SERIAL number of your motor when ordering parts. Please use the correct part numbers from the parts list. Payment for any parts ordered from the MINN KOTA parts department may be by Discover Card, Master Card or VISA. To order call 1-800-227-6433 or FAX 1-800-527-4464.

Item	Part Number	Description	Item	Part Number	Description
1	2-100-204	ARMATURE ASSEMBLY 12v 3.25	*29	2061300	SCREW-CLAM [2.EA]
2	788-015	RETAINING RING	*30	2011710	WASHER-CLAMP SCREW [2.EA]
3	2-200-079	HOUSING ASSEMBLY CENTER 3.25 TXT	31	2063605	T-BAR, PLASTIC
4	421-132	BRUSH END HOUSING ASSEMBLY 3.25	32	2062706	SPRING- (T-BAR)
5	2-400-187	PLAIN END HOUSING ASSEMBLY 3.25	33	2067201	LEVER-TILT BLACK
6	880-003	SEAL	34	2061810	HINGES-PLASTIC
7	880-006	SEAL W/SHIELD	35	2037301	BUSHING-HINGE [2.EA]
8	140-010	BALL BEARING	36	2062800	TENSION BLOCK-SNAP IN
9	188-052	BRUSH ASSEMBLY [2.EA]	37	2011385	SCREW, TENSION/KNOB
11	738-030	BRUSH PLATE W/HOLDER 3.25	38	2060515	PIN, TILT LEVER
12	975-032	SPRING-COMPRESSION [2.EA]	39	2061520	COLLAR-DEPTH
13	701-007	O-RING- THRU BOLT [2.EA]	40	2011365	SCREW-COLLAR/NEW KNOB
14	701-039	O-RING MK406460	41	2992523	LEADWIRE (WITH 14GA HD SPADE TERMINAL)
15	701-041	O-RING	42	2062905	STRAIN RELIEF
16	830-001	SCREW- SELF THREAD 8-32X1.7 [2.EA]	43	2026300	TIE WRAP
17	830-078	THRU BOLT 8-32X8.0 [2.EA]	44	2994040	CONTROL BOX
18	990-067	WASHER- STEEL THRUST	45	2060225	CONTROL BOX COVER
19	990-070	WASHER- NYLATRON [AS REQUIRED]	46	2065716	DECAL COVER ENDURA MAX 45
20	144-049	FLANGE BEARING (SERVICE ONLY)	47	2065730	COVER DECAL
21	2069257	MOTOR ASSEMBLY 12 V 3.25 VARIABLE SPD	48	2033401	SCREW-10-24 X 1-3/4
22	2032046	TUBE, COMPOSITE 36"	49	2383124	NUT-10-24 HEX
■	1378121	PROP W/DRIVE PIN, WASHER, NUT KIT	50	2012100	SCREW-8-18 X 5/8 [6.EA]
23	2061122	PROPELLER 3.25 HUB DIA	51	2990924	INNER HANDLE ASSEMBLY
24	2151726	WASHER- 5/16 STD SS	52	2012102	SCREW
25	2053101	NUT-PROP NYLOCK (MED) SS	53	2990913	OUTER HANDLE ASSEMBLY
26	2092600	PIN-DRIVE	54	2060009	FRONT BEARING
■	2771818	BRACKET & HINGE ASSEMBLY (INCLUDES 27-38)	55	2074070	BATTERY METER 12V
■	2771910	BRACKET ASSEMBLY (INCLUDES 27, 29, 30)	56	2302742	SPRING, DETENT, OFF
*27	2061910	BRACKET	■	2883460	SEAL AND O RING KIT
28	2060510	PIN-HINGE			

* This item is part of an assembly. This item cannot be sold separately due to machining and/or assembly that is required.

WIRING DIAGRAM

