

ENDURA MAX 55 (36" & 42") PARTS DIAGRAM

for use with "0" serial numbers

2-year warranty

12-volt 50 amps

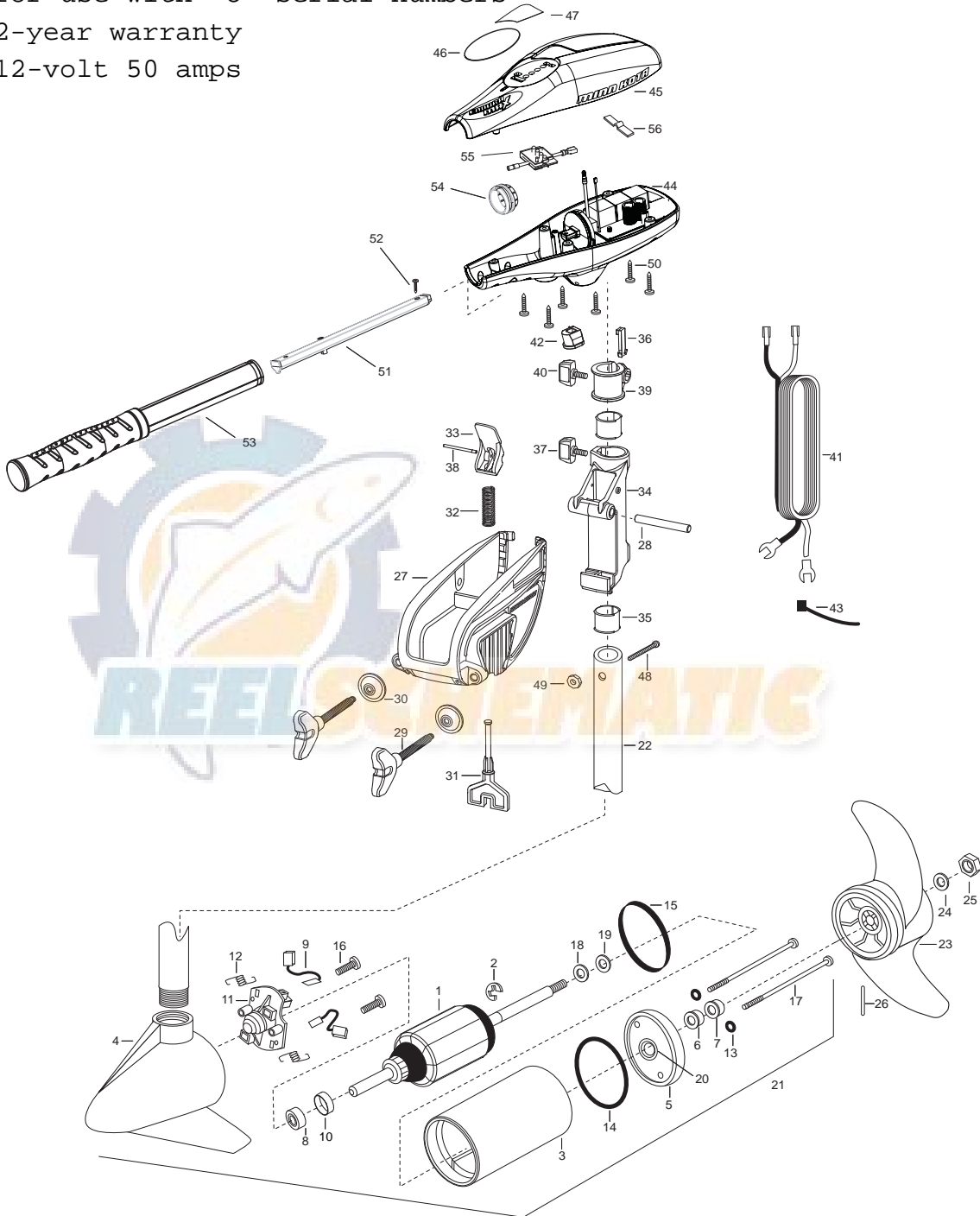

ENDURA MAX 55 (36" & 42") PARTS LIST

In the U.S.A., replacement parts may be ordered directly from MINN KOTA Parts Dept., 121 Power Dr., Mankato, MN 56002-8129. In Canada, parts may be ordered from any of the Canadian Authorized Service Centers. Visit minnkotamotors.com for a current listing. Be sure to provide the MODEL and SERIAL number of your motor when ordering parts. Please use the correct part numbers from the parts list. Payment for any parts ordered from the MINN KOTA parts department may be by Discover Card, Master Card or VISA. To order call 1-800-227-6433 or FAX 1-800-527-4464.

Item	Part Number	Description	Item	Part Number	Description
1	2-100-121	ARMATURE ASSEMBLY 12v 3.62	*27	2061910	BRACKET
2	788-015	RETAINING RING	28	2060510	PIN-HINGE
3	2-200-101	HOUSING ASSEMBLY CENTER 3.62 TXT	*29	2061300	SCREW-CLAM [2.EA]
4	421-065	BRUSH END HOUSING ASSEMBLY 3.62	*30	2011710	WASHER-CLAMP SCREW [2.EA]
5	2-400-101	PLAIN END HOUSING ASSEMBLY 3.62	31	2063605	T-BAR, PLASTIC
6	880-003	SEAL	32	2062706	SPRING- (T-BAR)
7	880-006	SEAL W/SHIELD	33	2067201	LEVER-TILT BLACK
8	140-010	BALL BEARING	34	2061810	HINGES-PLASTIC
9	188-036	BRUSH ASSEMBLY [2.EA]	35	2037301	BUSHING-HINGE [2.EA]
10	725-050	BRUSH RETENTION - PAPER TUBE	36	2062800	TENSION BLOCK-SNAP IN
11	738-036	BRUSH PLATE 3.62	37	2011385	SCREW, TENSION/KNOB
12	975-040	SPRING-TORSION [2.EA]	38	2060515	PIN, TILT LEVER
13	701-008	O-RING- THRU BOLT [2.EA]	39	2061520	COLLAR-DEPTH
14	701-081	O-RING	40	2011365	SCREW-COLLAR/NEW KNOB
15	337-036	GASKET	41	2992523	LEADWIRE (WITH 14GA HD SPADE TERMINAL)
16	830-007	SCREW- SELF THREAD 8-32X1.0 [2.EA]	42	2062905	STRAIN RELIEF
17	830-042	THRU BOLT 8-32X8.83 [2.EA]	43	2026300	TIE WRAP
18	990-067	WASHER- STEEL THRUST	44	2994040	CONTROL BOX
19	990-070	WASHER- NYLATRON [AS REQUIRED]	45	2060225	CONTROL BOX COVER
20	144-049	FLANGE BEARING (SERVICE ONLY)	46	2065718	DECAL COVER ENDURA MAX 55
21	2097083	MOTOR ASSEMBLY 12 V 3.62 VARIABLE SPD 36"	47	2065730	COVER DECAL
21	2097084	MOTOR ASSEMBLY 12 V 3.62 VARIABLE SPD 42"	48	2033401	SCREW-10-24 X 1-3/4
22	2032046	TUBE, COMPOSITE 36"	49	2383124	NUT-10-24 HEX
22	2032047	TUBE, COMPOSITE 42"	50	2012100	SCREW-8-18 X 5/8 [6.EA]
■	1378170	PROP W/DRIVE PIN, WASHER, NUT KIT	51	2990924	INNER HANDLE ASSEMBLY
23	2091170	PROPELLER 3.62 HUB DIA	52	2012104	SCREW-#6 x 1/2" SS
24	2151726	WASHER- 5/16 STD SS	53	2990913	OUTER HANDLE ASSEMBLY
25	2053101	NUT-PROP NYLOCK (MED) SS	54	2060009	FRONT BEARING
26	2092600	PIN-DRIVE	55	2074070	BATTERY METER 12V
■	2771818	BRACKET & HINGE ASSEMBLY (INCLUDES 27-28)	56	2302742	SPRING, DETENT, OFF
■	2771910	BRACKET ASSEMBLY (INCLUDES 27, 29, 30)	■	2888460	SEAL AND O RING KIT

* This item is part of an assembly. This item cannot be sold separately due to machining and/or assembly that is required.

WIRING DIAGRAM

