

RT55/SM/SC LATCH & DOOR

for use with "0" serial numbers
2-year warranty

55 LBS THRUST
12 VOLT 50 AMPS
42" & 52" SHAFT

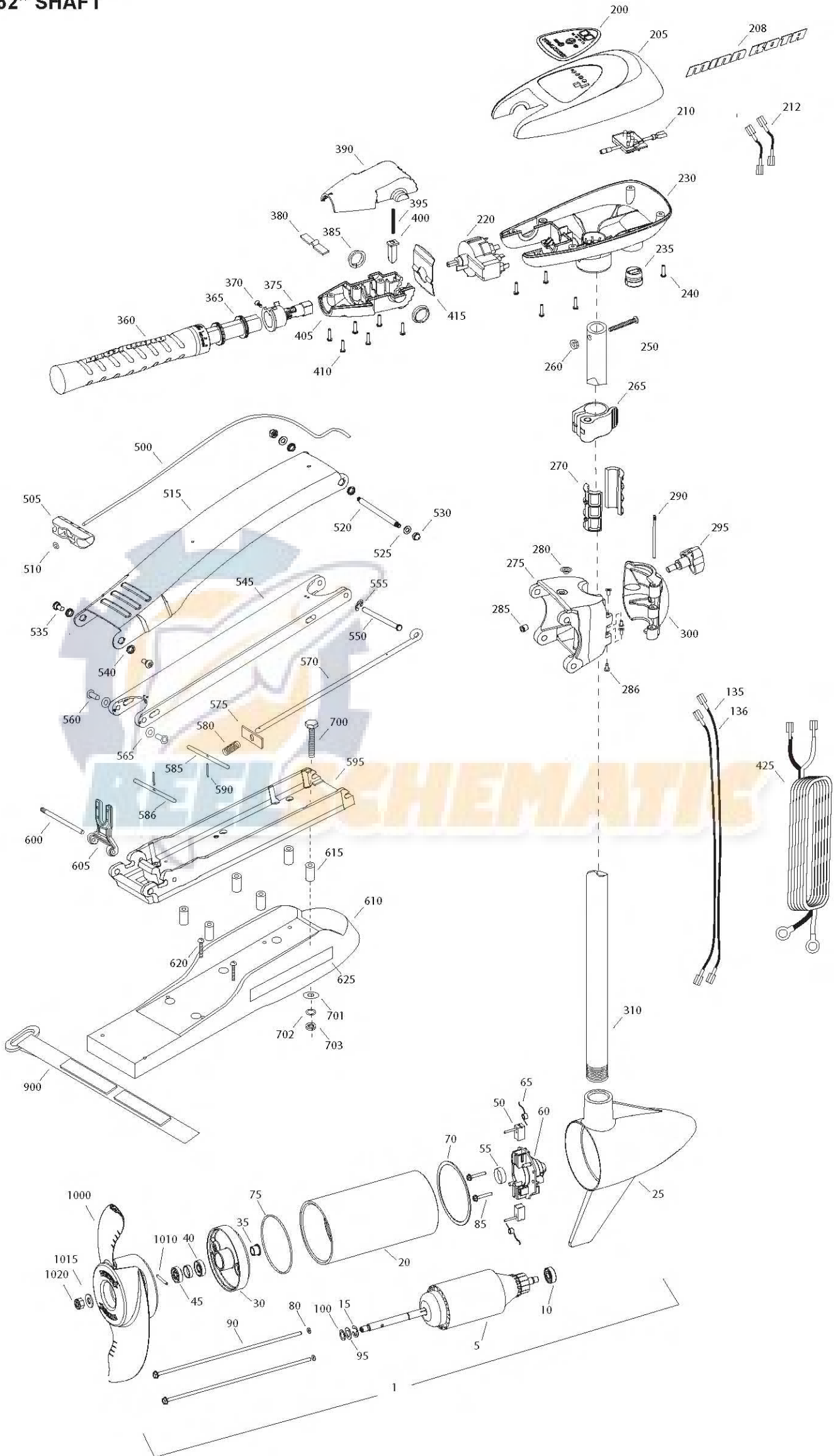

for use with "0" serial numbers
2-year warranty

Item	P/N	Description	Qty	Item	P/N	Description	Qty	Item	P/N	Description	Qty	Item	P/N	Description
1	2097097	12V Motor 52" SW	1	■	2990956	Handle assy, 5SPD [360-410]	1	■	1378131	Propeller kit WW2				
5	2-100-121	Armature assembly	1	360	2990451	Grip/handle assy, 5SPD [360-375]	1	■	2994875	Propeller bag assy				
10	140-010	Bearing	1	365	2060015	Bearing, handle	2	1000	2091160	Propeller WW2	1			
15	788-015	Retaining ring	1	370	2063405	Screw, #6 PFH SS	1	1010	2092600	Drive pin, small	1			
20	2-200-301	Center housing assembly	1	375	2884091	Yoke / spider assy, 5SPD	1	1015	2151726	Washer, prop, small	1			
25	2-300-337	Brush end housing assembly	1	380	2302742	Spring, detent, off	1	1020	2198400	Nut, nylock, prop, Anode	1			
30	2-400-337	Plain end housing assembly	1	385	2060005	Bearing, handle pivot	2							
35	144-049	Flange bearing	1	390	2060900	Handle pivot, top	1							
40	880-003	Seal	1	395	2302745	Spring, release button	1							
45	880-006	Seal with shield	1	400	2063700	Button, release	1							
50	188-036	Brush	2	405	2060905	Handle pivot, bottom	1							
55	725-050	Paper tube	1	410	2303412	Screw, #6 x 5/8 SS	6							
60	738-036	Brush plate assembly	1											
65	975-040	Brush spring	2	415	2062715	Spring, handle pivot	1							
70	337-036	Gasket	1	425	2992522	Leadwire assy	1							
75	701-081	O-ring, motor	1											
80	701-008	O-ring, thru-bolt	2	■	2991845	Mount, Bow Assy								
85	830-007	Screw, 8-32	2			500-625]								
90	830-042	Thru-bolt	2	500	2251601	Rope	1							
95	990-067	Washer, steel	2	505	2150400	Pull grip	1							
100	990-070	Washer, nylatron	2	510	2151700	Washer	1							
135	640-008	Leadwire, black	1	515	2264244	Arm, upper, std, sw	1							
136	640-107	Leadwire, red	1	520	2262604	Pin, bowguard, upper	1							
■	2888460	Seal and O-ring Kit		525	2261722	Washer, 5/16", ss	2							
				530	2223100	Nut, 5/16-18 SS	2							
200	2195656	Decal, c-box cover	1	535	2263500	Bolt, shoulder	2							
205	2060296	C-box cover	1	540	2293501	Bushing, SS	2							
208	2325666	Decal - MinnKota	2	545	2994351	Arm, Lower, std, sw	1							
210	2074080	Battery meter, 12v SW	1	550	2262622	Pin, clevis ss	1							
212	2070304	Wire, battery meter, blk	1	555	2263011	E-clip, ss	1							
	2070305	Wire, battery meter, red	1	560	2267318	Bushing, nyliner	2							
220	2064028	Switch 5 speed	1	565	2261708	Washer, spacer, .010 thk	as reqd							
230	2062506	Control box, 5 SPD, SW	1	570	2153603	Eyeshaft, ss	1							
235	2062905	Strain relief	1	575	2262703	Spring stop	1							
240	2303412	Screw, #6 x 5/8 SS	6	580	2152701	Spring, lock bar, ss	1							
250	2033403	Screw, #10-24 x 1-3/4" PPH SS	1	585	2233621	Lock bar, front, ss	1							
260	2383124	Nut, 10-24, nylock, SS	1	586	2233623	Lock bar, back, ss	1							
265	2991521	Cam lock/depth collar assy	1	590	2152612	Spring pin, ss	2							
				595	2773983	Bowplate w/ insert, std, fw	1							
■	2991808	Hinge & door assembly [270-300]		600	2260505	Hinge pin, ss	1							
270	2151532	Hinge sleeve	2	605	2293811	Yoke, Max	1							
275	2991782	Hinge base assembly	1	610	2263917	Motor rest, std, fw	1							
280	2232315	Eyelet SS	1	615	2261505	Spacer, motor rest	6							
286	2236001	Bushing, nyliner	4	620	2263434	Screw, #8, SS	2							
285	2264706	Insert, hinge base	1	625	2065677	Decal, motor rest	2							
290	2262642	Pin, hinge door	1											
295	2260902	Knob, door	1	■	2994830	Bag assembly								
300	2261859	Hinge door	1	700	2263431	Screw, 1/4-20 x 3 1/2" PPH, SS	6							
				701	2301720	Washer, rubber mounting	6							
310	2002013	Tube Composite 42"	1	702	2261713	Washer, 1/4 SS	6							
	2002014	Tube Composite 52"	1	703	2263101	Nut, 1/4-20 Nylock, SS	6							
				900	2263804	Strap, hold down (52" motor only)	1							

* This item is part of an assembly. This item cannot be sold separately due to machining and /or assembly that is required.

12-24 VOLT 5 SPEED MODELS

THIS IS A UNIVERSAL MULTI-VOLTAGE DIAGRAM. DOUBLE CHECK YOUR MOTORS VOLTAGE FOR PROPER CONNECTIONS

Riptide 55 is 12-volt only!

