

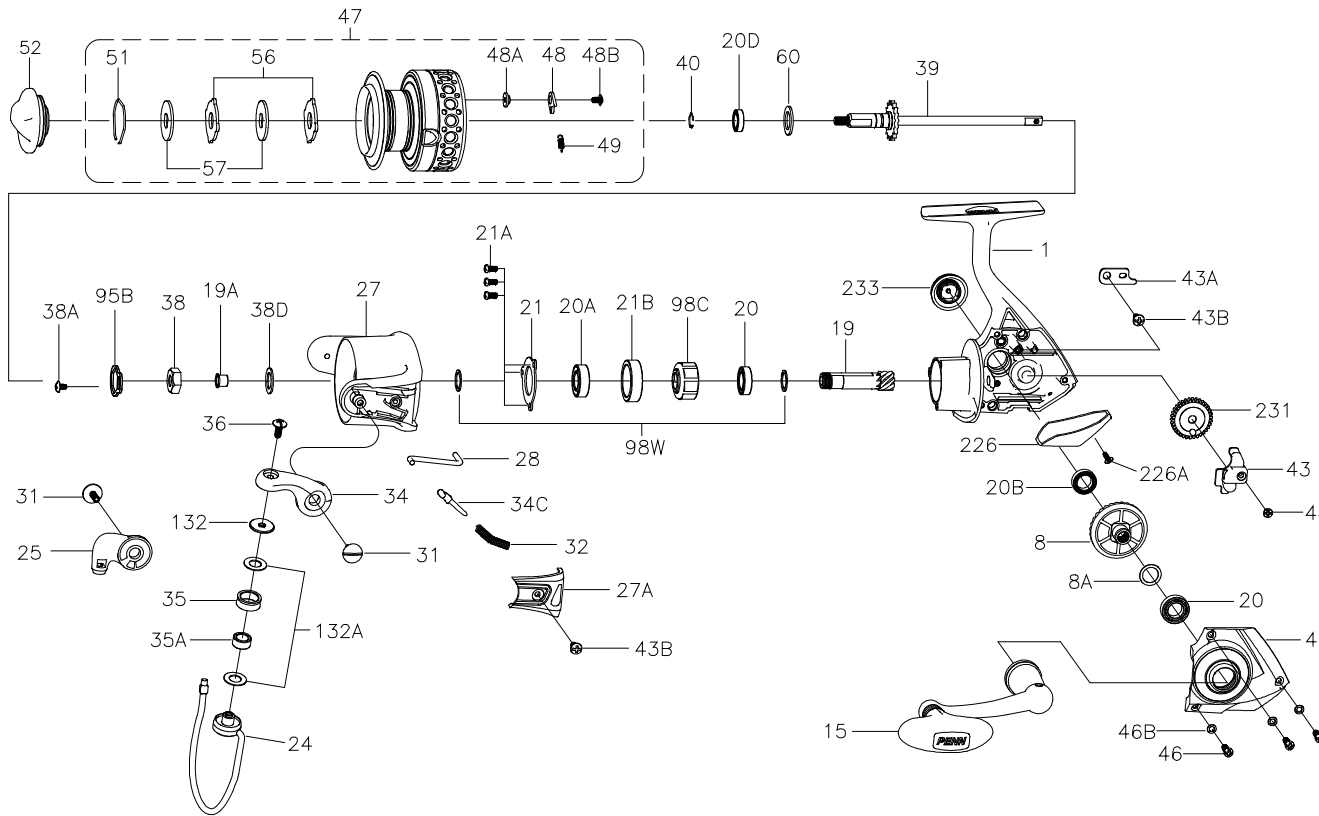

PARTS LIST FOR MODEL BTLB3000



KEY NO.	PART NO.	DESCRIPTION
24	1308054	24-CFT3000 Bail Wire Assembly
25	1308056	25-CFT3000 Bail Holder
27	1324177	27-BTLII3000 Rotor
27A	1324178	27A-BTLII3000 Bail Pivot Cover
28	1308061	28-CFT3000 Trip Lever
31	1324169	31-BTLII4000 Bail Arm Screw (2 req)
32	1191586	32-3000SG Bail Spring
34	1308064	34-CFT3000 Bail Arm
34C	1308065	34C-CFT3000 Pivot Arm
35	1324170	35-BTLII4000 Line Roller
35A	1308067	35A-CFT3000 Line Roller Bushing
36	1191699	36-3000SG Bail Stud Screw
38	1191728	38-3000SG Rotor Nut
38A	1324171	38A-BTLII4000 Rotor Locking Plate Screw
38D	1308070	38D-CFT3000 Rotor Nut Washer
39	1308071	39-CFT3000 Main Shaft Assembly
40	1308073	40-CFT3000 Bearing Lock Spring
43	1200531	43-4000SG Crosswind Block
43A	1191818	43A-3000SG Crosswind Block Plate
43B	1191826	43B-3000SG Screw (2 req)
44	1191843	44-3000SG Crosswind Block Screw
45	1324179	45-BTLII3000 Housing Cover Assembly
46	1191901	46-3000SG Housing Cover Screw (3 req)
46B	1191907	46B-3000SG Housing Cover Washer (3 req)
47	1508053	47-BTLB3000 Spool Assembly
48	1211604	48-3000SG Click Tongue
48A	1214226	48A-3000SG Click Tongue Washer
48B	1214189	48B-3000SG Spool Click Screw
49	1211605	49-3000SG Click Tongue Spring
51	1308078	51-CFT3000 Drag Retaining Ring
52	1324174	52-BTLII4000 Drag Knob Assembly
56	1308080	56-CFT3000 Drag Washer (2 req)
57	1192043	57-3000SG Keyed Washer (2 req)
60	1192060	60-3000SG Thrust Washer
95B	1308081	95B-CFT3000 Rotor Locking Plate
98C	1308082	98C-CFT3000 Clutch/Sleeve Assembly
98W	1204004	98W-3000PUR Clutch Washer (2 req)
132	1192296	132-3000SG Roller Washer
132A	1192302	132A-3000SG Line Roller Washer (2 req)
226	1308083	226-CFT3000 Rear Cover
226A	1192473	226A-3000SG Rear Cover Screw
231	1192498	231-3000SG Crosswind Gear
233	1211608	233-3000BTL Bearing Cover Assembly

KEY NO.	PART NO.	DESCRIPTION
1	1508054	1-BTLB3000 Housing Assembly
8	1308047	8-CFT3000 Main Gear
8A	1191028	8A-3000SG Shim
15	1508051	15-BTLB4000 Handle Assembly
19	1191231	19-3000SG Pinion Gear
19A	1191252	19A-3000SG Pinion Bushing
20	1308050	20-CFT3000 Ball Bearing (2 req)
20A	1308051	20A-CFT3000 Upper Pinion Ball Bearing
20B	1211610	20B-5000BTL Ball Bearing
20D	1211588	20D-3000BTL Spool Ball Bearing
21	1308052	21-CFT3000 Bearing Retainer
21A	1192644	21A-3000SG Bearing Retainer Screw (3 req)
21B	1308053	21B-CFT3000 Collar

407-BTLB3000 Rev. 0 16-10-18

1508073