

Shakespeare®

WILD SERIES

Model WDFLY7/8

SKP-FLY-WDFLY7/8-00

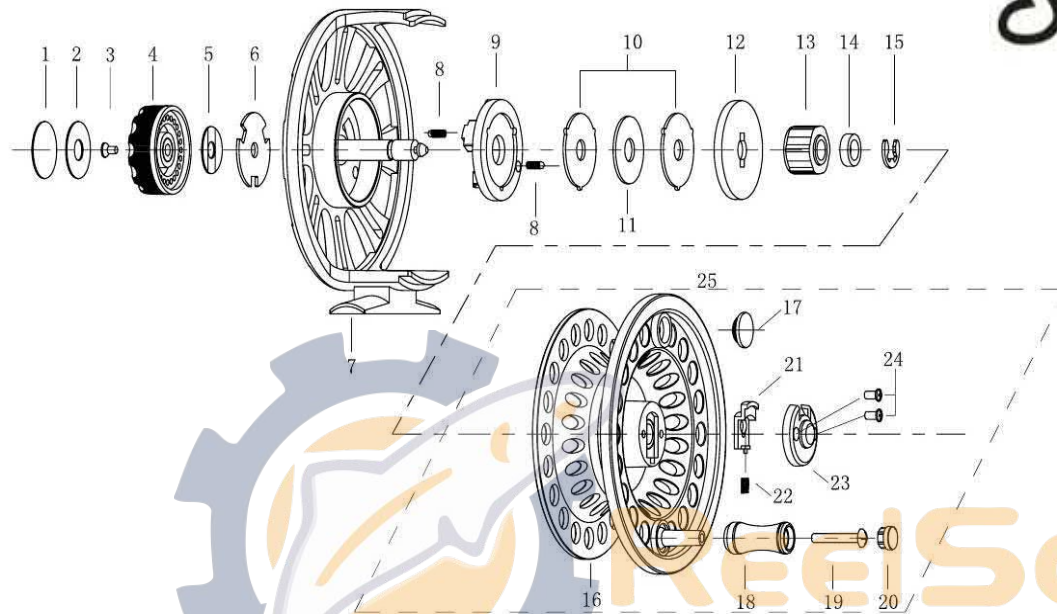

Item	Description	SAP #	Item	Description	SAP #	Item	Description	SAP #
1	Badge	1403713	10	Ear Washer	1403693	19	Handle Rivet	1403702
2	Badge Washer	1403685	11	Drag Washer	1403694	20	Handle Knob Cap	1403703
3	Drag Knob Screw	1403686	12	One Way Clutch Retainer	1403695	21	Button	1403704
4	Drag Knob	1403687	13	One Way Clutch	1403696	22	Button Spring	1403705
5	Drag Knob Disc Washer	1403688	14	Bushing	1403697	23	Button Cover	1403706
6	Drag Knob Washer	1403689	15	Clip	1403698	24	Button Screw	1403707
7	Frame	1403714	16	Spool	1403710	25	Spool Assembly	1404840
8	Spring Assy	1403691	17	Counter Weight	1403700			
9	Drag Knob Base	1403692	18	Handle Knob	1403701			