

SILSTAR

NOVA 20

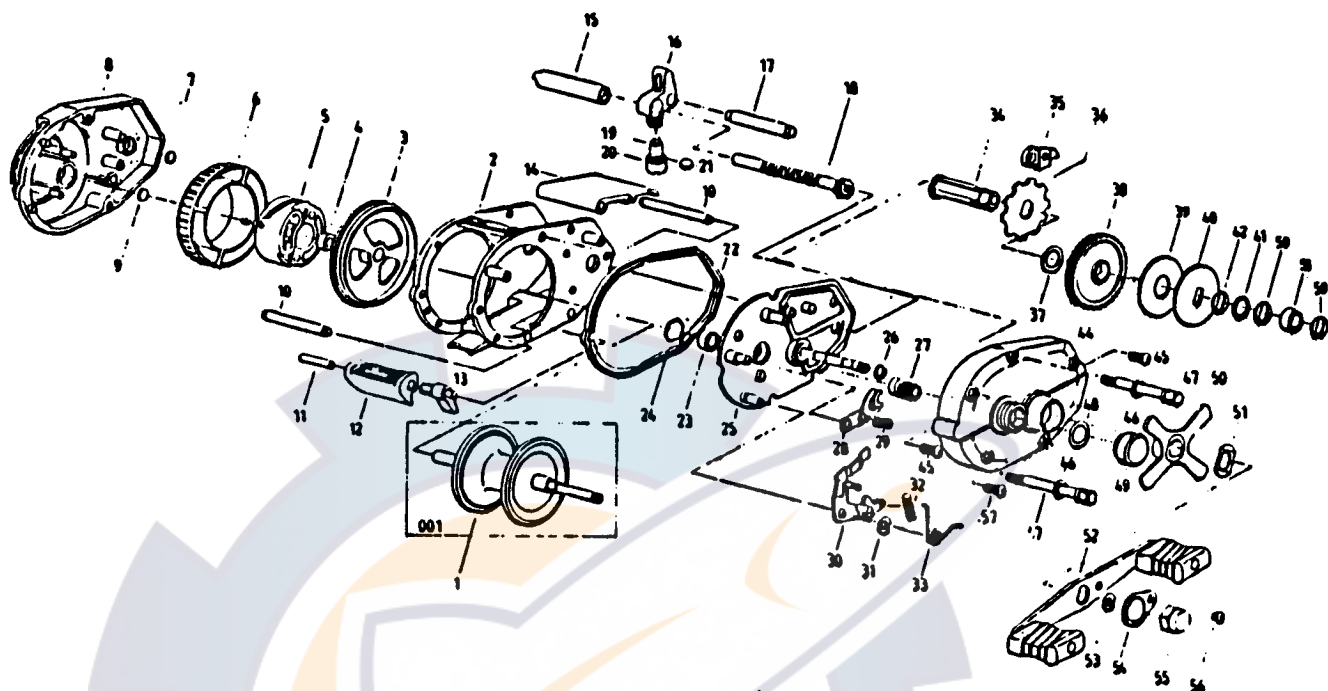

REF.NO	PART NO.	DESCRIPTION	PRICE	REF. NO.	PART NO.	DESCRIPTION	PRICE
1	001-0002	SPOOL ASSY	\$3.00	30	030-0001	YOKE PLATE ASSY	\$0.50
2	002-0002	FRAME	\$2.25	31	031-0001	RETAINER	\$0.35
3	003-0001	FRAME COLLAR	\$0.40	32	032-0001	YOKE S/P	\$0.35
4	004-0001	BEARING	\$3.10	33	033-0001	YOKE PLATE S/P	\$0.35
5	005-0001	MAGNET HOLDER ASSY	\$3.00	34	034-0001	DRIVE SHAFT	\$1.00
6	006-0001	ADJUST HOLDER	\$0.35	35	035-0001	A-R-PAWL ASSY	\$0.35
7	007-0001	CARRIAGE S/C W/S	\$0.35	36	036-0001	RATCHET	\$0.35
8	008-0002	L.S. PLATE ASSY	\$2.00	37	037-0001	WASHER	\$0.35
9	009-0001	SPOOL TENSION W/S	\$0.35	38	038-0002	DRIVE GEAR	\$1.00
10	010-0002	TOP C/O BAR	\$0.35	39	039-0001	WASHER	\$0.35
11	011-0002	PUSH LEVER BAR	\$0.35	40	040-0001	DISK D W/S	\$0.35
12	012-0002	PUSH LEVER	\$0.35	41	041-0001	WASHER	\$0.35
13	013-0001	LEVER HOLDER	\$0.35	42	042-0001	S/P W/S	\$0.35
14	014-0002	TOP COVER	\$0.35	44	044-0002	RIGHT SIDE PLATE	\$2.00
15	015-0002	LEVER WIDE GUIDE	\$0.50	45	045-0001	SCREW	\$0.35
16	016-0001	L.G. PAWL HOLDER	\$0.50	46	046-0001	STABILIZER BAR W/S	\$0.35
17	017-0002	STABILIZER BAR	\$0.35	47	047-0002	STABILIZER BAR	\$0.35
18	018-0002	CARRIAGE S/C ASSY	\$2.10	48	048-0001	O RING	\$0.35
19	019-0001	L-GUIDE PAWL	\$0.50	49	049-0001	CAST CONTROL CAP ASSY	\$0.40
20	020-0001	PAWL CAP	\$0.35	50	050-0001	STAR DRAG	\$0.40
21	021-0001	WASHER	\$0.35	51	051-0001	FRICTION W/S	\$0.35
22	022-0001	SIDE RING	\$0.35	52	052-0001	HANDLE ASSY	\$1.75
23	023-0001	BALL BEARING	\$2.10	53	053-0001	RETAINER	\$0.35
24	024-0001	RETAINER	\$0.35	54	054-0001	HANDLE NUT RETAINER	\$0.35
25	025-0001	SET PLATE ASSY	\$2.10	55	055-0001	HANDLE NUT	\$0.35
26	026-0001	WASHER	\$0.35	56	056-0001	RETAINER S/C	\$0.35
27	027-0002	PINION ASSY	\$0.95	57	057-0002	SCREW	\$0.35
28	028-0001	YOKE ASSY	\$0.50	58	058-0001	BALL BEARING	\$2.10
29	029-0001	YOKE PUSH S/P	\$0.35	59	059-0001	WASHER	\$0.35

PARTS LIST FOR SILSTAR :

NOVA 20

* When ordering parts for your Silstar reel, be sure to include the following:

- 1) Complete Model Number and Letter. Example: BT 80 B
- 2) Specify Color for FX, BT,CX,ER,EC series reels.