

SILSTAR EC-5060

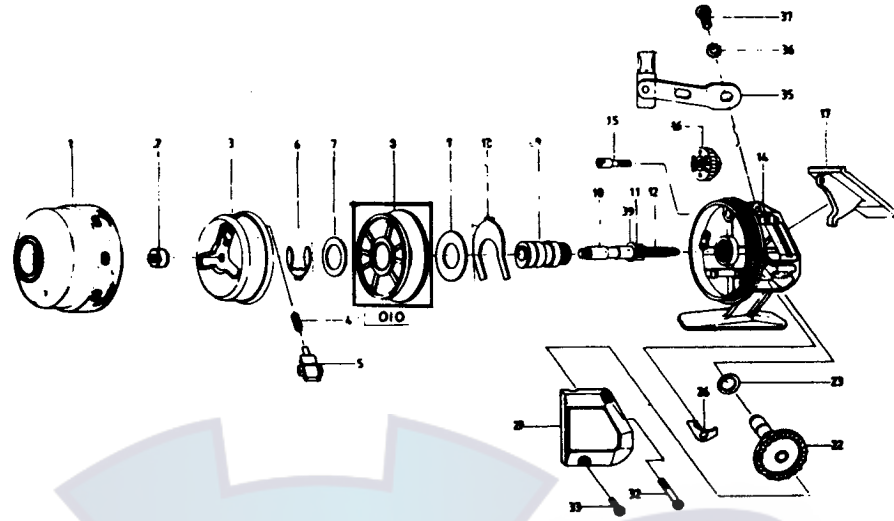

REF. NO.	PART NO.	DESCRIPTION	REF. NO.	PART NO.	DESCRIPTION
1	001-0915	FRONT COVER	15	015-0515	DRAG SCREW
2	002-0115	ROTOR NUT	16	016-0115	DRAG DIAL
3	003-0515	ROTOR A'SSY	17	017-0915	PUSH BUTTON
4	004-0315	SPRING	22	022-0415	DRIVE GEAR
5	005-0515	PICK UP	23	023-0415	DRIVE GEAR A/D W/S
6	006-0115	"E" RING	26	026-0415	ANTI-R-CLAW
7	007-0115	WASHER	29	029-0915	BODY COVER
8	008-0515	SPOOL	32	032-0115	SCREW
9	009-0315	METAL BEARING	33	033-0315	BODY COVER SCREW
10	010-0515	MAIN SHAFT	35	035-0515	HANDLE A'SSY
11	011-0415	PINION	36	036-0115	TOOTH WASHER
12	012-0315	SPRING	37	037-0415	SCREW
13	013-0515	LEAF SPRING	39	039-0115	WASHER
14	014-0915	BODY	40	040-0115	WASHER

PARTS LIST FOR 5060 REEL