

SILSTAR

BT35

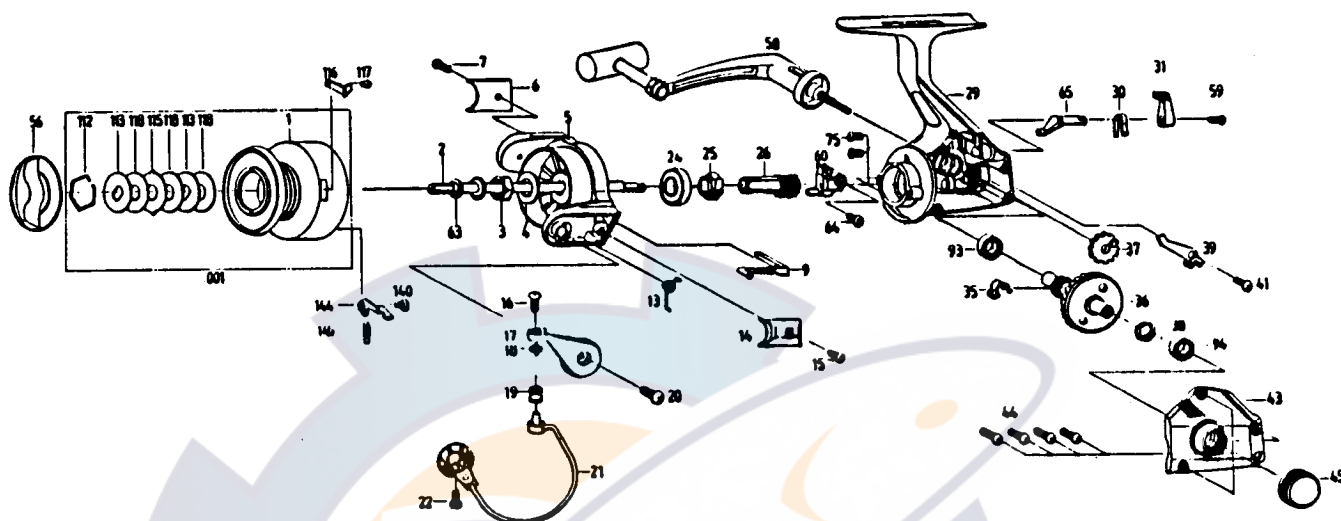

REF.NO	PART NO.	DESCRIPTION	PRICE	REF. NO.	PART NO.	DESCRIPTION	PRICE
1	001-4255	SPOOL ASSY	\$5.00	30	030-4217	LEAF S/P	\$0.35
2	002-4246	MAIN SHAFT ASSY	\$1.10	31	031-4217	ANTI-R-LEVER	\$0.35
3	003-0110	ROTOR NUT	\$0.35	35	035-4216	ANTI-R-CLAW ADJ	\$0.35
4	004-0110	ROTOR W/S	\$0.35	36	036-4221	DRIVE GEAR	\$0.90
5	005-4241	ROTOR	\$1.80	37	037-2610	O/S GEAR	\$0.35
6	006-4223	B/H C/O	\$0.35	38	038-4214	DRIVE GEAR ADJ W/S	\$0.35
7	007-0410	B/H C/O S/C	\$0.35	39	039-4222	ANTI-R-CLAW	\$0.35
9	009-4221	BAIL K/L	\$0.35	41	075-4217	ANTI-R-CLAW S/C	\$0.35
13	013-4218	BAIL S/P	\$0.35	43	043-4253	BODY C/O	\$1.10
14	006-4223	ARM LEVER C/O	\$0.35	44	044-4217	BODY C/O S/C	\$0.35
15	007-0410	ARM LEVER C/O S/C	\$0.35	45	045-0710	HANDLE S/C CAP	\$0.35
16	016-2610	L-SLIDER S/C	\$0.35	56	056-4229	DRAG KNOB	\$0.75
17	017-4219	ARM LEVER	\$0.35	58	058-4226	HANDLE ASSY	\$3.00
18	018-4214	L-SLIDER W/S	\$0.35	59	059-4214	ANTI-R-CLAW S/C	\$0.35
19	019-4213	L-ROLLER	\$0.75	60	060-4219	O/S SLIDER	\$0.35
20	057-0710	ARM LEVER S/C	\$0.35	63	063-4214	WASHER	\$0.35
21	021-4232	BAIL ASSY	\$1.25	64	075-1810	O/S SLIDER S/C	\$0.35
22	057-0710	B/H S/C	\$0.35	65	065-4220	ANTI-R-CAM	\$0.35
24	024-4215	BALL BEARING	\$3.10	75	075-4217	SCREW	\$0.35
25	025-4213	RATCHET	\$0.25	93	093-4216	BALL BEARING	\$5.45
26	026-4224	PINION	\$1.25	94	093-4216	BALL BEARING	\$5.45
29	029-4257	BODY	\$2.15				

PARTS LIST FOR SILSTAR : BT35

* When ordering parts for your Silstar reel, be sure to include the following:

- 1) Complete Model Number and Letter. Example: BT 80 B
- 2) Specify Color for FX, BT,CX,ER,EC series reels.