

SILSTAR

CT35

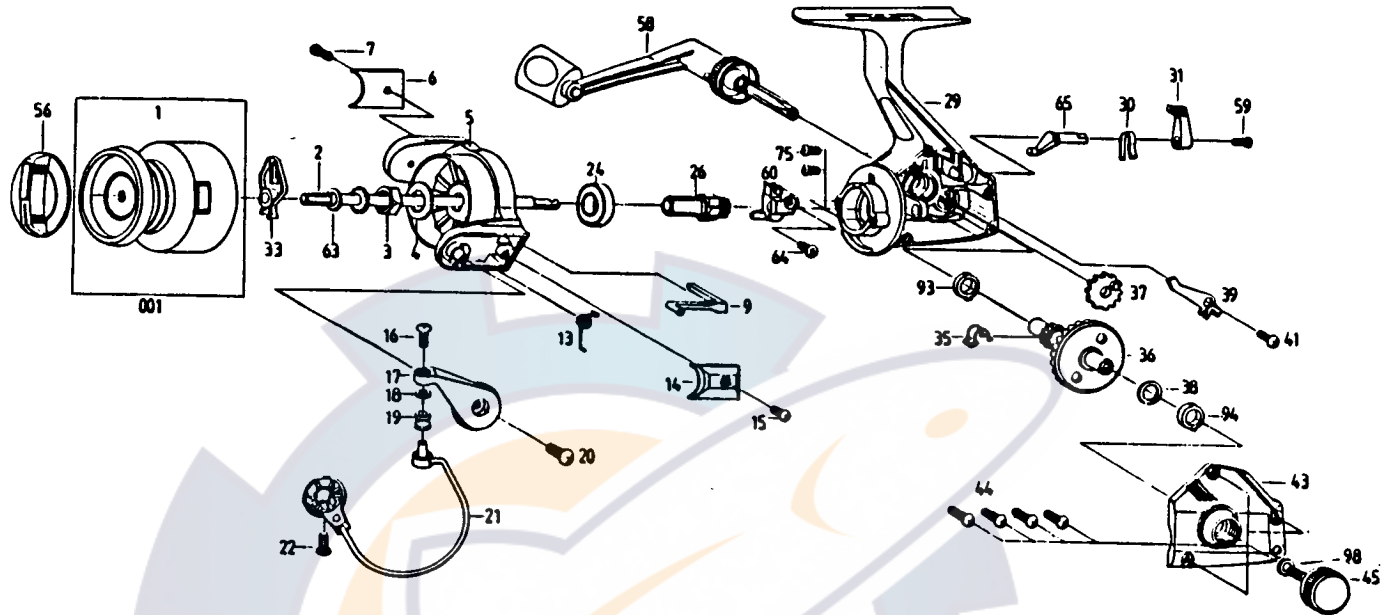

REF.NO	PART NO.	DESCRIPTION	PRICE	REF. NO.	PART NO.	DESCRIPTION	PRICE
1	001-4250	SPOOL ASSY	\$2.25	31	031-4217	A-R-LEVER	\$0.35
2	002-4246	MAIN SHAFT ASSY	\$1.80	33	033-4214	CLICK CLAW	\$0.35
3	003-0110	ROTOR NUT	\$0.35	35	035-4216	A-R-CLAW ADJ S/P	\$0.35
4	004-0110	ROTOR W/S	\$0.35	36	036-4220	DRIVE GEAR	\$1.80
5	005-4238	ROTOR	\$1.80	37	037-2610	O/S GEAR	\$0.35
6	006-4223	B/H C/O	\$0.35	38	038-0710	DRIVE GEAR ADJ W/S	\$0.35
7	007-4214	B/H C/O S/C	\$0.35	39	039-4222	A-R-CLAW	\$0.35
9	009-4221	BAIL K/L	\$0.35	41	075-4217	A-R-CLAW S/C	\$0.35
13	013-4218	BAIL S/P	\$0.35	43	043-4252	BODY C/O ASSY	\$0.90
14	006-4223	ARM LEVER C/O	\$0.35	44	044-4215	BODY C/O S/C	\$0.35
15	007-4214	ARM LEVER C/O S/C	\$0.35	45	045-4217	HANDLE S/C CAP	\$0.60
16	016-4215	L-SLIDER S/C	\$0.35	56	056-4229	DRAG KNOB ASSY	\$1.10
17	017-4219	ARM LEVER	\$0.35	58	058-2110	HANDLE ASSY	\$3.00
18	018-4214	L-SLIDER W/S	\$0.35	59	044-0910	A-R-CAM S/C	\$0.35
19	019-0710	L-ROLLER	\$0.35	60	060-4219	O/S SLIDER	\$0.35
20	041-4214	ARM LEVER	\$0.35	63	063-4213	SPOOL ADJ W/S	\$0.35
21	021-4232	BAIL ASSY	\$1.10	64	075-1810	O/S HOLDER S/C PIN	\$0.35
22	041-4214	B/H S/C	\$0.35	65	065-4220	A-R-CAM	\$0.60
24	024-0110	BALL BEARING	\$1.60	75	075-4217	BEARING PLATE S/C	\$0.35
26	026-4223	PINION/RATCHET	\$1.65	93	093-4214	BEARING	\$0.35
29	029-4252	BODY ASSY	\$2.50	94	093-4214	BEARING	\$0.35
30	030-4217	LEAF S/P	\$0.35	98	098-4211	NYLON W/S	\$0.35

PARTS LIST FOR SILSTAR : CT35

* When ordering parts for your Silstar reel, be sure to include the following:

- 1) Complete Model Number and Letter. Example: BT 80 B
- 2) Specify Color for FX, BT,CX,ER,EC series reels.