

# SILSTAR

CT80B

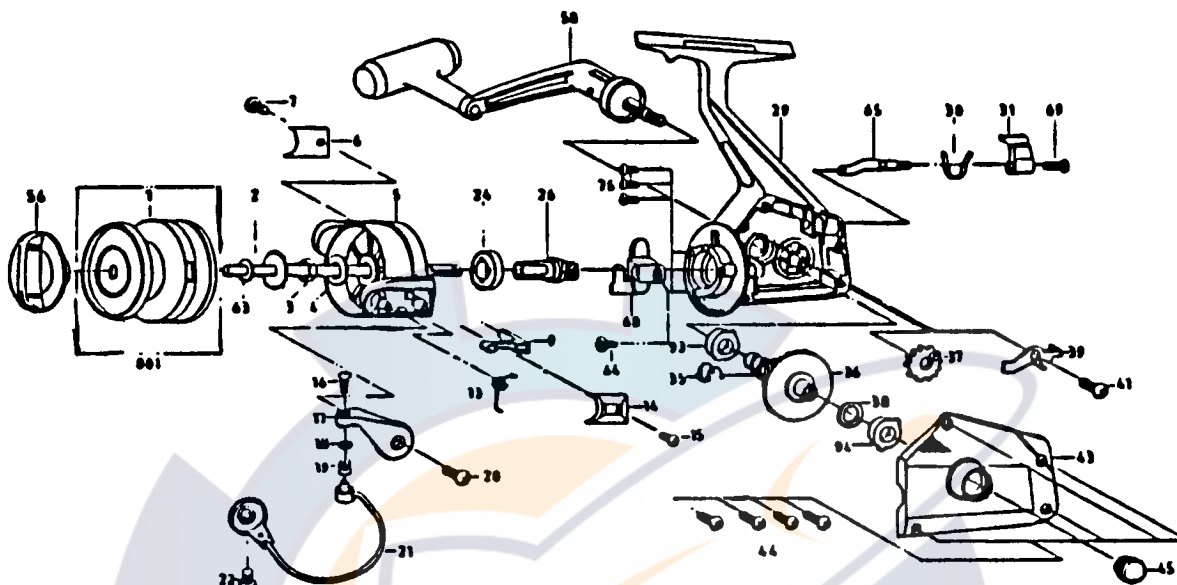

REF.NO	PART NO.	DESCRIPTION	PRICE	REF. NO.	PART NO.	DESCRIPTION	PRICE
1	001-4253	SPOOL ASSY	\$3.20	30	030-4219	LEAF S/P	\$0.35
2	002-5192	MAIN SHAFT ASSY	\$3.70	31	031-4219	A-R-LEVER	\$0.35
3	003-0210	ROTOR NUT	\$0.35	35	035-4213	A-R-CLAW ADJ S/P	\$0.35
4	004-0210	ROTOR W/S	\$0.35	36	036-4217	DRIVE GEAR	\$3.35
5	005-5192	ROTOR	\$3.00	37	037-0110	O/S GEAR	\$0.35
6	006-4218	B/H C/O	\$0.35	38	038-0110	DRIVE GEAR ADJ W/S	\$0.35
7	075-4213	B/H C/O S/C	\$0.35	39	039-4223	A-R-CLAW	\$0.35
9	009-4218	KICK LEVER	\$0.35	40	040-4213	DRAG S/P	\$0.35
13	013-4217	BAIL S/P	\$0.35	41	041-4214	A-R-CLAW S/C	\$0.35
14	006-4218	ARM LEVER C/O	\$0.35	43	043-5192	BODY C/O	\$1.25
15	075-4213	ARM LEVER C/O S/C	\$0.35	44	044-4216	BODY C/O S/C	\$0.35
16	016-0110	L-SLIDER S/C	\$0.35	45	045-0110	HANDLE S/C CAP	\$0.35
17	017-4218	ARM LEVER	\$0.35	56	056-4228	DRAG KNOB	\$1.10
18	018-4216	L-ROLLER W/S	\$0.35	58	058-1210	HANDLE ASSY	\$3.35
19	019-0110	L-ROLLER	\$0.35	60	060-4221	O/S SLIDER	\$0.60
20	020-4215	ARM LEVER S/C	\$0.35	63	063-1210	SPOOL ADJ W/S	\$0.35
21	021-4235	BAIL ASSY	\$1.10	64	059-0110	O/S SLIDER S/C	\$0.35
22	020-4215	B/H S/C	\$0.35	65	065-4222	A-R-CAM	\$0.60
24	024-4212	BEARING	\$1.95	69	044-1010	A-R-LEVER S/C	\$0.35
26	026-4231	PINION/RATCHET	\$2.20	75	075-4214	BEARING ADJ S/C	\$0.35
29	029-5192	BODY ASSY	\$4.60	93	093-4213	BEARING	\$0.35
				94	093-4213	BEARING	\$0.35
				144	144-5190	L-BEARING	\$0.35

**PARTS LIST FOR SILSTAR : CT80B**

\* When ordering parts for your Silstar reel, be sure to include the following:

- 1) Complete Model Number and Letter. Example: BT 80 B
- 2) Specify Color for FX, BT,CX,ER,EC series reels.