

SILSTAR

CX80B

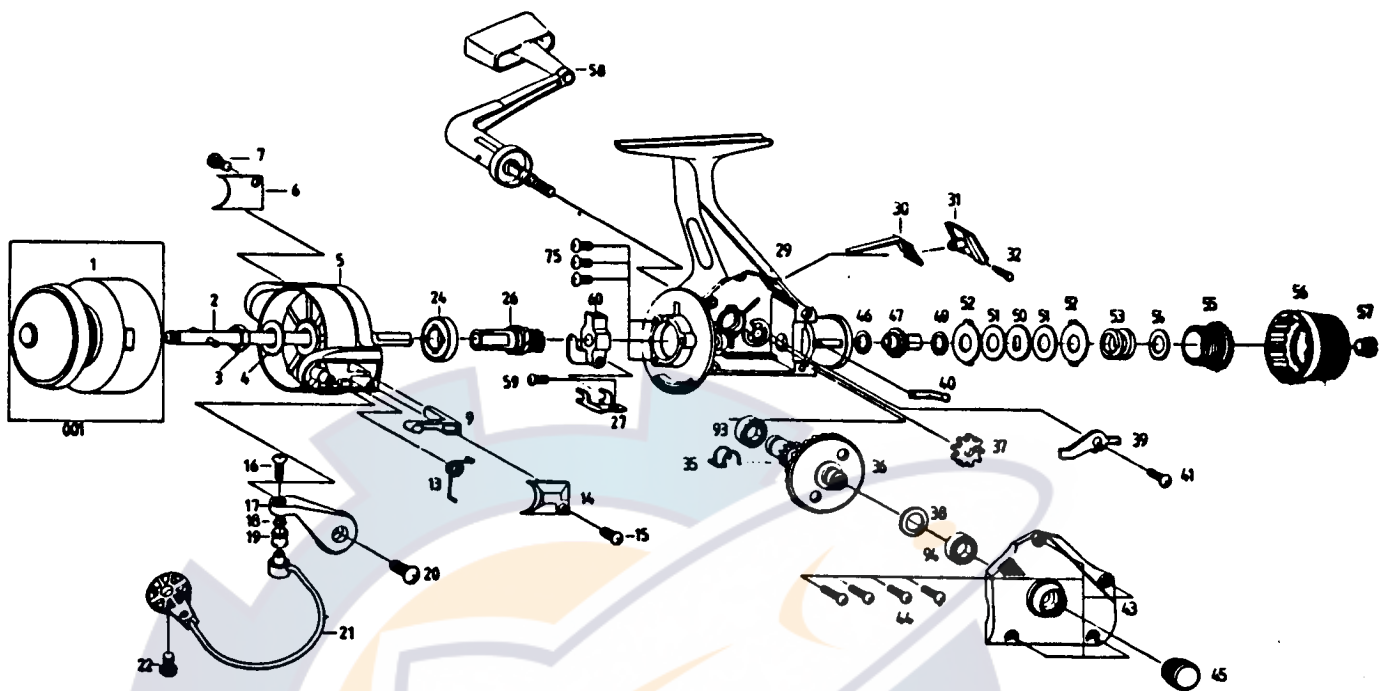

REF.NO	PART NO.	DESCRIPTION	PRICE	REF. NO.	PART NO.	DESCRIPTION	PRICE
1	001-4240	SPOOL ASSY	\$4.75	37	037-0110	O/S GEAR	\$0.35
2	002-4238	MAIN SHAFT ASSY	\$2.65	38	038-0110	DRIVE GEAR ADJ W/S	\$0.35
3	003-0210	ROTOR NUT	\$0.35	39	039-4218	A-R-CLAW	\$0.35
4	004-0210	ROTOR W/S	\$0.35	40	040-4213	DRAG LEAF S/P	\$0.35
5	005-4231	ROTOR ASSY	\$3.00	41	041-4214	A-R-CLAW S/C	\$0.35
6	006-4218	B/H C/O	\$0.35	43	043-5176	BODY C/O ASSY	\$2.15
7	007-4211	B/H C/O S/C	\$0.35	44	044-3010	BODY C/O S/C	\$0.35
9	009-4218	BAIL K/L	\$0.35	45	045-0110	HANDLE S/C CAP	\$0.35
13	013-4217	BAIL S/P	\$0.35	46	046-4217	WASHER	\$0.35
14	006-4218	ARM LEVER C/O	\$0.35	47	047-4217	CLICK METAL	\$0.35
15	007-4211	A-R-LEVER C/O S/C	\$0.35	49	049-4215	B W/S	\$0.35
16	016-0410	L-SLIDER S/C	\$0.35	50	050-5174	D W/S	\$0.35
17	017-4218	ARM LEVER	\$1.10	51	051-5174	C W/S	\$0.35
18	018-4216	L-ROLLER COLLAR	\$0.35	52	052-4215	A W/S	\$0.35
19	019-0110	L-ROLLER	\$0.35	53	053-4218	COIL S/P	\$0.35
20	020-4212	ARM LEVER S/C	\$0.35	54	054-4213	PRESSURE W/S	\$0.35
21	021-4226	BAIL ASSY	\$1.60	55	055-4217	PRESSURE	\$0.35
22	020-4212	B/H S/C	\$0.35	56	056-4226	DRAG KNOB	\$0.90
24	024-4212	BALL BEARING	\$1.95	57	020-4212	DRAG S/C	\$0.35
26	026-4217	PINION/RATCHET	\$2.25	58	058-4220	HANDLE ASSY	\$3.70
27	027-4214	RETAINER	\$0.35	59	059-0110	RETAINER S/C	\$0.35
29	029-5176	BODY ASSY	\$7.20	60	060-4215	O/S SLIDER	\$0.35
30	030-4215	LEAF S/P	\$0.35	75	075-4214	BEARING S/C	\$0.35
31	031-4212	A-R-LEVER	\$0.35	93	093-4213	BEARING	\$0.35
32	032-5174	PIN	\$0.35	94	093-4213	BEARING	\$0.35
35	035-4213	A-R-CLAW S/P	\$0.35	144	144-5174	L-BEARING	\$1.95
36	036-4217	DRIVE GEAR	\$2.30				

PARTS LIST FOR SILSTAR : CX80B

* When ordering parts for your Silstar reel, be sure to include the following:

- 1) Complete Model Number and Letter. Example: BT 80 B
- 2) Specify Color for FX, BT,CX,ER,EC series reels.