

# SILSTAR ET-2072

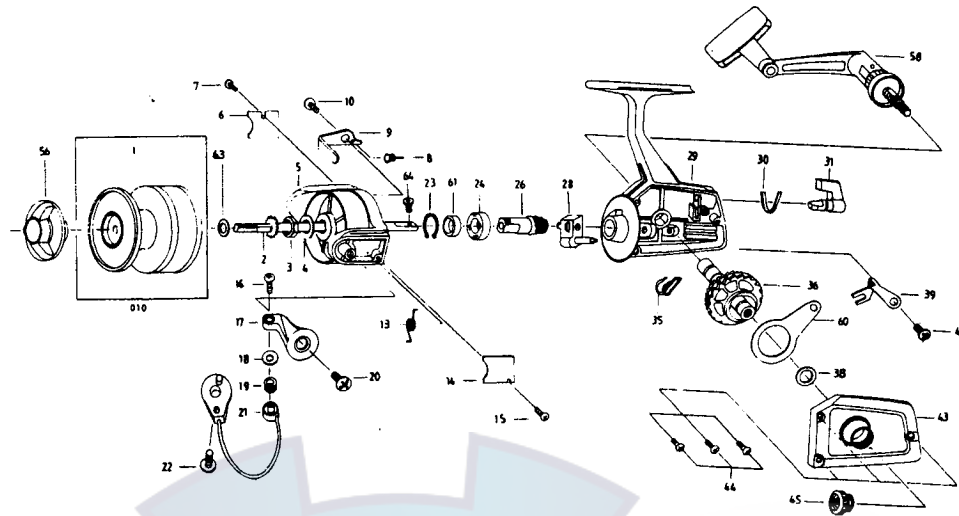

REF. NO.	PART NO.	DESCRIPTION	REF. NO.	PART NO.	DESCRIPTION
1	001-3610	SPOOL A'SSY	24	024-0110	BEARING
2	002-1210	MAIN SHAFT A'SSY	26	026-1210	PINION
3	003-0110	ROTOR NUT	28	028-1210	O/S HOLDER
4	004-1210	ROTOR WASHER	29	029-3610	BODY A'SSY
5	005-3610	ROTOR	30	030-1210	LEAF SPRING
6	006-3610	BAIL HOLDER COVER	31	031-1210	ANTI-R-LEVER
7	007-0110	BAIL HOLDER C/O S/C	35	035-1210	ANTI-R-CLAW A/D
8	008-0110	BAIL KICK LEVER S/P	36	036-1210	DRIVE GEAR
9	009-1210	BAIL KICK LEVER	38	038-1210	DRIVE GEAR A/D WASHER
10	010-0110	BAIL KICK LEVER S/C	39	039-1210	ANTI-R-CLAW
13	013-1210	BAIL SPRING	41	041-1210	ANTI-R-CLAW S/C
14	014-3610	ARM LEVER COVER	43	043-3610	BODY COVER A'SSY
15	015-0110	ARM LEVER C/O S/C	44	044-0110	BODY COVER S/C
16	016-0110	LINE SLIDER S/C	45	045-0110	HANDLE SCREW CAP
17	017-1210	ARM LEVER	56	056-1210	DRAG KNOB A'SSY
18	018-0110	LINE ROLLER COLLAR	58	058-1210	HANDLE A'SSY
19	019-0110	LINE ROLLER	60	060-1210	O/S SLIDER
20	020-0110	ARM LEVER S/C	61	061-1210	COLLAR
21	021-1210	BAIL A'SSY	63	063-1210	SPOOL A/D WASHER
22	022-0110	BAIL HOLDER S/C	64	064-1210	O/S HOLDER S/C
23	023-0110	RETAINER RING			

PARTS LIST FOR 2072 REEL