

# SILSTAR EX-2141

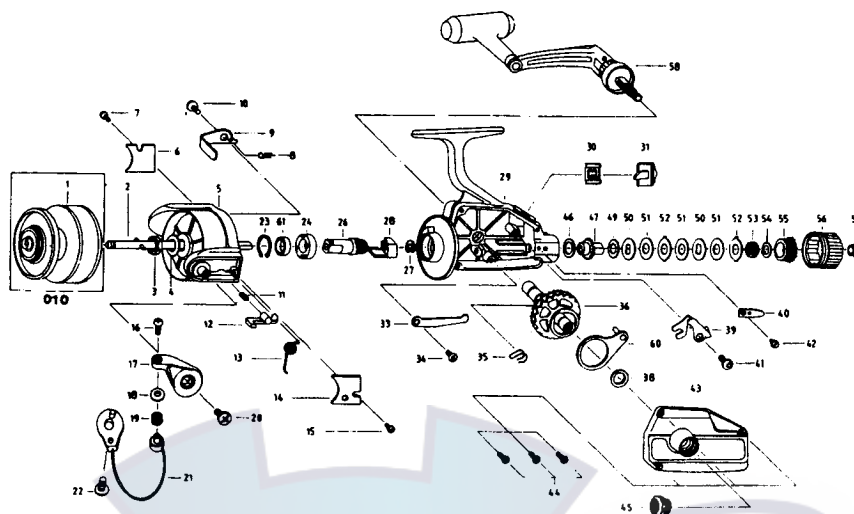

REF. NO.	PART NO.	DESCRIPTION	REF. NO.	PART NO.	DESCRIPTION
1	001-3910	SPOOL A'SSY	31	031-0310	ANTI-R-LEVER
2	002-0510	MAIN SHAFT	32		
3	003-0110	ROTOR NUT	33	033-0310	CLICK CLAW
4	004-0110	ROTOR WASHER	34	034-0310	CLICK CLAW S/C
5	005-3910	ROTOR	35	035-0310	ANTI-R-CLAW A/D
6	006-3910	BAIL HOLDER C/O	36	036-0310	DRIVE GEAR
7	007-0310	BAIL HOLDER C/O S/C	37		
8	008-0110	BAIL KICK LEVER S/P	38	038-0310	DRIVE GEAR A/D W/S
9	009-0510	BAIL KICK LEVER	39	039-0310	ANTI-R-CLAW
10	010-0310	BAIL KICK LEVER S/C	40	040-0310	DRAG LEAF S/P
11	011-0310	BAIL STOPPER S/P	41	041-0310	ANTI-R-CLAW C/D
12	012-0310	BAIL STOPPER	42	042-0310	DRAG LEAF S/P S/C
13	013-0310	BAIL SPRING	43	043-3910	BODY COVER A'SSY
14	014-3910	ARM LEVER C/O	44	044-0310	BODY COVER S/C
15	015-0310	ARM LEVER C/O S/C	45	045-0310	HANDLE SCREW CAP
16	016-0310	LINE SLIDER S/C	46	046-0310	WASHER
17	017-0310	ARM LEVER	47	047-0310	CLICK METAL
18	018-0310	LINE ROLLER COLLAR	48		
19	019-0310	LINE ROLLER	49	049-0310	DISK B WASHER
20	020-0110	ARM LEVER S/C	50	050-0310	DISK D WASHER
21	021-0510	BAIL A'SSY	51	051-0310	DISK C WASHER
22	022-0110	BAIL HOLDER S/C	52	052-0310	DISK A WASHER
23	023-0110	RETAINER RING	53	053-0310	COIL SPRING
24	024-0110	BEARING	54	054-0310	PRESSURE WASHER
25			55	055-0310	PRESSURE
26	026-0310	PINION	56	056-0310	DRAG KNOB A'SSY
27	027-0310	RETAINER	57	057-0310	DRAG KNOB S/C
28	028-0310	O/S HOLDER	58	058-0510	HANDLE A'SSY
29	029-3910	BODY A'SSY	59		
30	030-0310	LEAF SPRING	60	060-0310	O/S SLIDER

PARTS LIST FOR 2141 REEL