

SILSTAR EX-2161

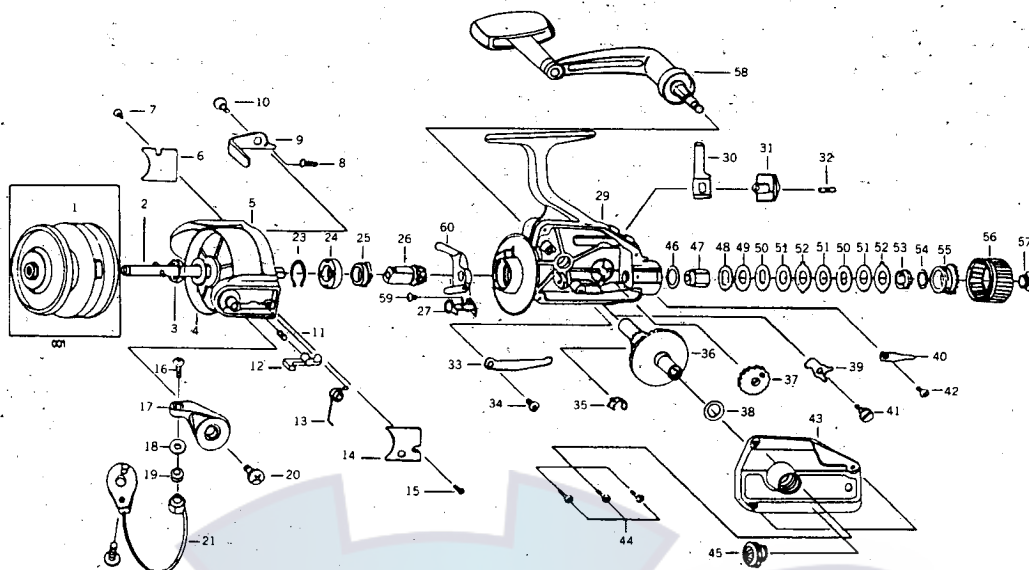

REF. NO.	PART NO.	DESCRIPTION	REF. NO.	PART NO.	DESCRIPTION
1	001-4110	SPOOL A'SSY	32	032-0110	PIN
2	002-0110	MAIN SHAFT A'SSY	33	033-0110	CLICK CLAW
3	003-0110	ROTOR NUT	34	034-0110	CLICK CLAW S/C
4	004-0110	ROTOR WASHER	35	035-0110	ANTI-R-CLAW A/D
5	005-4110	ROTOR	36	036-0110	DRIVE GEAR
6	006-4110	BAIL HOLDER COVER	37	037-0110	O/S GEAR
7	007-0110	BAIL HOLDER C/O S/C	38	038-0110	DRIVE GEAR A/D W/S
8	008-0110	BAIL KICK LEVER S/P	39	039-0110	ANTI-R-CLAW
9	009-1910	BAIL KICK LEVER	40	040-0110	DRAG LEAF S/P
10	010-0110	BAIL KICK LEVER S/C	41	041-0110	ANTI-R-CLAW S/C
11	011-0110	BAIL STOPPER S/P	42	042-0110	DRAG LEAF S/P S/C
12	012-0110	BAIL STOPPER	43	043-4110	BODY COVER A'SSY
13	013-0110	BAIL SPRING	44	044-0110	BODY COVER S/C
14	014-4110	ARM LEVER COVER	45	045-0110	HANDLE SCREW CAP
15	015-0110	ARM LEVER COVER S/C	46	046-0110	WASHER
16	016-0110	LINE SLIDER S/C	47	047-0110	CLICK METAL
17	017-0110	ARM LEVER	48	048-0110	CLICK GEAR
18	018-0110	LINE ROLLER COLLAR	49	049-0110	DISK B WASHER
19	019-0110	LINE ROLLER	50	050-0110	DISK D WASHER
20	020-0110	ARM LEVER S/C	51	051-0110	DISK C WASHER
21	021-1910	BAIL A'SSY	52	052-0110	DISK A WASHER
22	022-0110	BAIL HOLDER S/C	53	053-0110	COIL SPRING
23	023-0110	RETAINER RING	54	054-0110	PRESSURE WASHER
24	024-0110	BEARING	55	055-0110	PRESSURE
25	025-0110	RATCHET	56	056-0110	DRAG KNOB A'SSY
26	026-0110	PINION	57	057-0110	DRAG KNOB S/C
27	027-0110	RETAINER	58	058-0110	HANDLE A'SSY
29	029-4110	BODY A'SSY	59	059-0110	SCREW
30	030-0110	LEAF SPRING	60	060-0110	O/S SLIDER
31	031-0110	ANTI-R-LEVER			

PARTS LIST FOR 2161 REEL