

# SILSTAR

## GXB80M (Manual Trip)

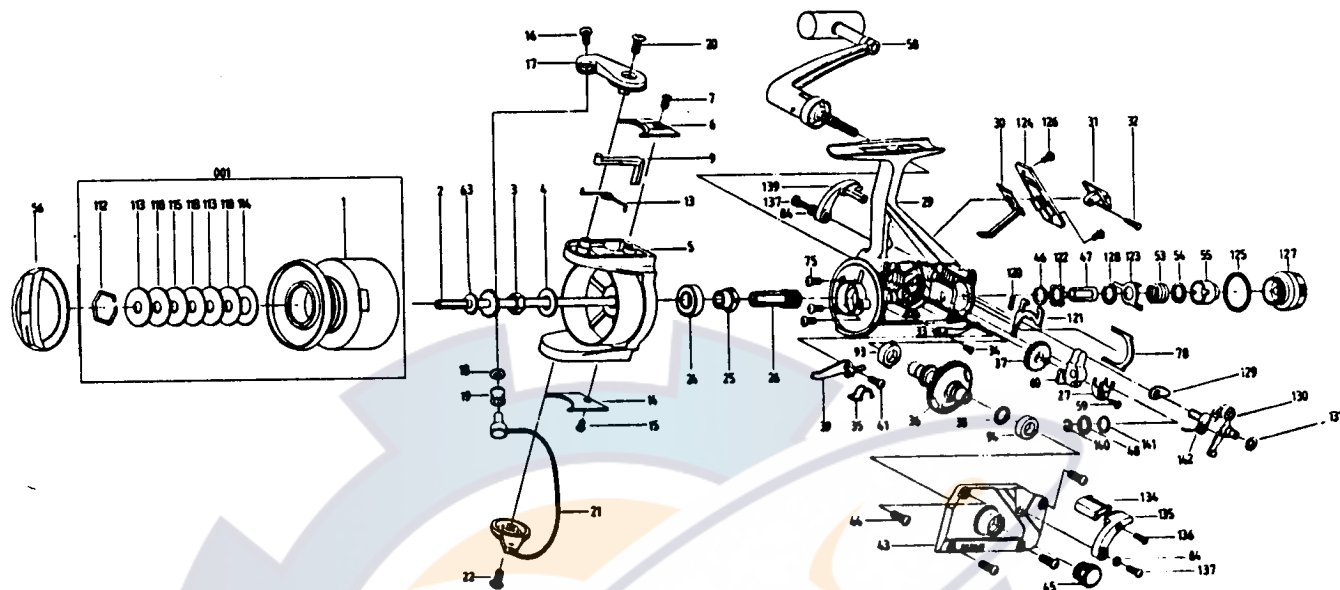

REF.NO	PART NO.	DESCRIPTION	PRICE	REF. NO.	PART NO.	DESCRIPTION	PRICE
1	001-5120	SPOOL ASSY	\$7.20	48	048-4212	CLICK GEAR	\$0.35
2	002-4245	MAIN SHAFT ASSY	\$3.90	53	053-4219	COIL S/P	\$0.35
3	003-0210	ROTOR NUT	\$0.35	54	054-4214	PRESSURE W/S	\$0.35
4	004-4215	ROTOR W/S	\$0.35	55	055-4218	PRESSURE	\$1.10
5	005-4245	ROTOR	\$2.65	56	056-4232	DRAG KNOB ASSY	\$2.00
6	006-4222	B/H C/O	\$0.35	58	058-5115	HANDLE ASSY	\$4.40
7	007-4211	B/H C/O S/C	\$0.35	59	059-0110	S/C	\$0.35
9	009-4220	BAIL K/L	\$0.35	60	060-4218	O/S SLIDER	\$0.60
13	013-4217	BAIL S/P	\$0.35	76	076-4214	BEARING PLATE S/C	\$0.35
14	006-4218	ARM LEVER C/O	\$0.35	78	078-4212	RETAINER	\$0.35
15	007-4211	ARM LEVER C/O S/C	\$0.35	84	084-4213	W/S	\$0.35
16	016-0410	L-SLIDER S/C	\$0.35	93	093-4213	BEARING	\$0.35
17	017-4218	ARM LEVER	\$0.35	94	093-4213	BEARING	\$0.35
18	018-4216	L-ROLLER COLLAR	\$0.35	120	120-4211	CLUTCH S/P	\$0.35
19	019-4212	L-ROLLER	\$0.75	121	121-4211	CLUTCH	\$0.35
20	020-4212	ARM LEVER S/C	\$0.35	122	122-4211	FE RATCHET	\$0.35
21	021-4231	BAIL ARM	\$1.45	123	123-4211	A W/S	\$0.35
22	020-4212	B/H S/C	\$0.35	124	124-4211	A-R-LEVER C/O	\$0.60
24	024-4214	BALL BEARING	\$3.10	125	125-4211	DRAG RING	\$0.35
25	025-4212	RATCHET	\$0.35	126	126-4211	S/C	\$0.35
26	026-4222	PINION	\$2.80	127	127-4211	TENSION DRAG	\$1.25
27	027-4214	RETAINER	\$0.35	128	046-4219	W/S	\$0.35
29	029-4250	BODY ASSY	\$7.20	129	129-4211	CLUTCH CAM	\$0.35
30	030-4216	LEAF S/P	\$0.35	130	130-4211	CLUTCH ARM ASSY	\$0.60
31	031-4216	A-R-LEVER	\$0.35	131	131-4212	CLUTCH ARM W/S	\$0.35
32	032-0110	PIN	\$0.35	132	132-5114	KICKING P/L	\$0.35
33	033-4213	CLICK CLAW	\$0.35	133	133-5114	BAIT FE P/L	\$0.75
34	007-4214	CLICK CLAW S/C	\$0.35	134	134-4211	BAIT FE BRIDGE	\$0.35
36	035-4213	A-R-CLAW ADJ S/P	\$0.35	135	135-4211	BAIT FE LEVER (L)	\$0.75
36	036-4219	DRIVE GEAR ASSY	\$3.35	136	136-4211	BRIDGE S/C	\$0.35
37	037-4219	O/S GEAR	\$0.60	137	016-0410	LEVER S/C	\$0.35
38	038-0110	DRIVE GEAR ADJ W/S	\$0.35	138	138-4211	S/C	\$0.35
39	039-4221	A-R-CLAW	\$0.35	139	139-4211	BAIT FE LEVER (R)	\$0.75
41	041-4214	A-R-CLAW S/C	\$0.35	140	140-4211	RETAINER	\$0.35
43	043-4250	BODY C/O	\$2.15	141	141-4211	W/S	\$0.35
44	044-3010	BODY C/O S/C	\$0.35	142	142-4211	CLUTCH ARM S/P	\$0.35
45	045-4216	HANDLE S/C CAP	\$0.35	143	143-4211	CLUTCH ARM P/L S/P	\$0.35
46	046-4219	W/S	\$0.35	144	144-4211	L-BEARING	\$0.35
47	047-4218	CLICK METAL	\$0.35				

**PARTS LIST FOR SILSTAR :**

**GXB80M**

\* When ordering parts for your Silstar reel, be sure to include the following:

- 1) Complete Model Number and Letter. Example: BT 80 B
- 2) Specify Color for FX, BT,CX,ER,EC series reels.