

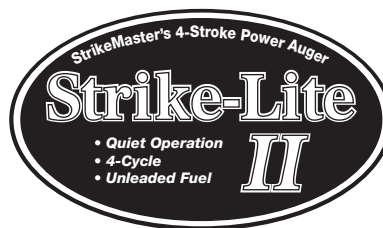

# OPERATING MANUAL

## Strike-Lite II / 4-Stroke



**! ATTENTION !**

**You *MUST* add Crankcase Oil to your new Auger prior to your first use! We recommend using StrikeMaster's 10W30 Weight Conventional cold weather 4-Cycle Oil included with this auger.**



**ATTENTION:**  
**FOR BEST PERFORMANCE IDLE ENGINE FOR 1-2 MINUTES BEFORE YOU START DRILLING.**

StrikeMaster Corporation  
17217 198th Avenue • Big Lake, Minnesota 55309  
Phone (763) 263-8999 • Fax (763) 263-8986  
[www.strikemaster.com](http://www.strikemaster.com)

**It is recommended that everyone who uses this product should read the StrikeMaster OPERATING MANUAL and view the videos at <http://www.strikemaster.com/video.html> before operating**

# StrikeMaster Ice Augers

Ice Fishing has become one of the fastest growing and most popular winter sports, allowing the ardent angler the opportunity to enjoy his or her favorite outdoor activity.

When you selected a StrikeMaster power ice auger, you selected a product that has gained a reputation as the quality leader since 1946. And, there is no doubt that this year's model is the finest ever produced by StrikeMaster Corporation.

Your new StrikeMaster ice auger has all of the most wanted features in a power ice auger, to assure many years of enjoyable ice fishing. Some of these features such as workmanship, engineering excellence, and dependability have long been standards at StrikeMaster. Your new power ice auger boasts many new features while retaining the best features developed in previous years to enhance your ice fishing experience and add to your satisfaction in selecting StrikeMaster.

We know that you are anxious to go fishing and use your new power ice auger, but before you go fishing, it is important and to your advantage to spend a few minutes getting acquainted with your new StrikeMaster power ice auger. There is no better way to acquaint yourself with the product than to read the Owners Manual and Operating Instructions. A few minutes spent studying this manual before your first ice fishing outing will be time well spent.

**Record your Model and Serial No.'s immediately after purchase (see bottom of pg. 10). Also, please return the enclosed WARRANTY CARD or submit information on our website to validate your limited warranty.**



**THIS SYMBOL POINTS OUT IMPORTANT SAFETY INSTRUCTIONS WHICH IF NOT FOLLOWED COULD ENDANGER THE PERSONAL SAFETY AND/OR PROPERTY OF YOURSELF AND OTHERS. READ AND FOLLOW ALL INSTRUCTIONS IN THIS MANUAL AND ANY PROVIDED WITH OR ON THE EQUIPMENT ON WHICH THIS ENGINE IS USED BEFORE ATTEMPTING TO OPERATE YOUR STRIKEMASTER POWER ICE AUGER.**



## TABLE OF CONTENTS

Important Safeguards	2	Service Information	3
Adjustments	7	Starting/Operation	2, 5
Assembly Instructions	2	Stopping Engine	3, 5-6
Maintenance	5-7	Storage	7
Fuel Requirements	4-5	Warranty Card	10

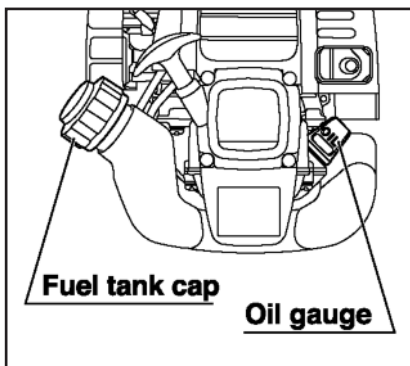

**Your new 4-stroke auger engine does NOT come with oil or gasoline. You will need to add oil and gasoline prior to your first use. Use unleaded gas only. Using a gas/oil mixture will damage the motor.**

**Fill crankcase with StrikeMaster's Conventional 4-Cycle Oil, included with this manual (See instructions).**

**See page 4 for complete instructions for adding fuel and oil to your new auger.**



## IMPORTANT SAFEGUARDS

It is recommended that everyone who uses this product should read the StrikeMaster OPERATING MANUAL and view the videos at <http://www.strikemaster.com/video.html> before operating

1. **⚠ DO NOT** use this product for any purpose other than cutting ice fishing holes. Ice augers are precision cutting tools built for the ice fisherman, and must be properly maintained and handled with caution during both cutting and transporting. When not in use, always store with blade guard attached.
2. **⚠ DO NOT** use attachments other than those available from the manufacturer.
3. **⚠ DO NOT** alter this product in any manner; doing so is dangerous and **voids all warranties**.
4. **⚠ DO NOT** allow children or adults weighing under 100 lbs. to operate this equipment.
5. **⚠ DO NOT** operate under the influence of drugs or alcohol.
6. **⚠ DO NOT** allow your body, loose clothing, drawstrings, scarves, hats or other materials to come in contact with the Powerhead, Starter Assembly or Auger (Drill) unit at any time.
7. **⚠ DO NOT** operate if, upon pulling the starter rope or after drilling holes, the auger (drill) unit rotates or if the rope pulls hard. **DO NOT OPERATE**. Have the unit checked by a qualified mechanic.
8. **⚠ DO NOT** allow the engine to run or operate while moving or transporting to another location.
9. **⚠ DO NOT** continue to use this product in the event of mechanical or electrical failure.
10. **⚠** This product produces considerable cutting force that is felt by the operator. Make sure your feet are firmly planted and that the handles are held firmly while operating this product.
11. **⚠** Always check the operation of the throttle system to ensure the carburetor control is completely returning to the idle position when the throttle lever is released.
12. **⚠ Check cutting blades and auger shaft screws before and after each use to make sure they are tight.**
13. **⚠** During operation, the auger unit could possibly stop. Be prepared at all times to release the throttle lever.
14. **⚠ Everyone who uses this product should read this manual before operating this unit.**
15. **⚠** The cutting blades on the ice auger are razor sharp. Use extreme care when handling.
16. **⚠** The manufacturer recommends that all augers, Lazer Mag Xpress, Strike-Lite, Lazer 224, Mag 2000, Magnum, Lazer Mag, Lazer Pro and Electra Lazer 12000 DP be used for ice cutting only.

## ⚠ Assembly ⚠

Carefully remove blade guard and make sure blade bolts are tight.

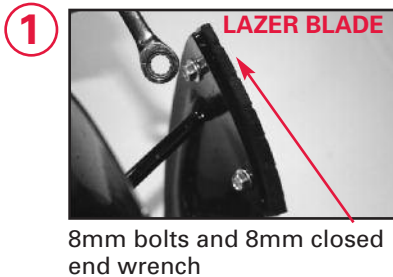

② Remove Metric Allen wrench and unscrew the collar bolt from auger.

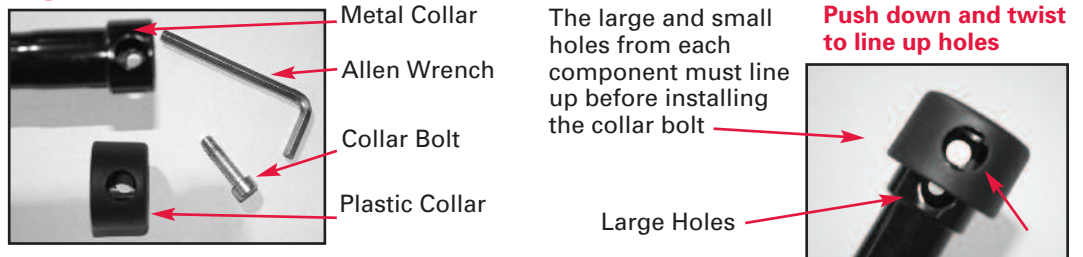

③ Remove Black plastic cap from drive shaft. Insert auger into drive shaft and install collar bolt.

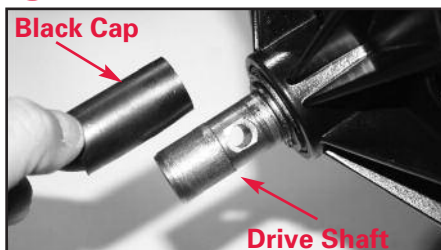

Collar bolt inserts into the large hole, passes through the drive shaft and threads into the small hole of the metal collar. Make sure bolt is tight. Some wiggle is normal between the power head and auger. Check and tighten often.

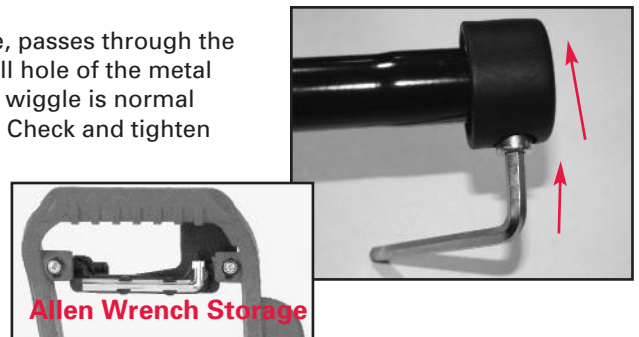

4. After assembly is complete, you can conveniently store your allen wrench on the underside of the throttle pedal.
5. **It is recommended that the collar bolt be checked and torqued firmly before and after every use.**

## ⚠ Operation ⚠

1. **Start engine as explained in this manual. (See page 4-7). For best cutting performance, run engine at idle for one minute before drilling.**
2. Hold the unit in a vertical position with your **right hand** pushing downward to **open throttle**, and your **left hand** firmly holding the **opposite handle**.
3. This product produces considerable cutting force that is felt by the operator. Make sure your feet are firmly planted and that the handles are held firmly while operating this product, centrifugal clutch will engage and the auger will begin to rotate.
4. During the operation of cutting, the auger could possibly stop if it comes in contact with a foreign object or if it binds in the hole. Be prepared at all times to release the throttle lever to avoid rotation of the handle assembly.

- After cutting ice fishing holes, the unit should be placed on the ice in a horizontal position, **making sure that the gas tank is facing down\***. Be sure to replace the blade guard to protect against personal injury, damage to the auger shaft or blade(s). (**Never store or stand an ice auger upright in a partially drilled ice fishing hole.**)



**Note: In ice depths deeper than the flighting of the auger, it is helpful to bring the auger up some to remove the ice chips, this will make the remaining ice easier to drill.**

## ! **Stop Engine** !

- After completing the cutting of an ice fishing hole, **STOP** the engine by allowing the engine to return to idle and moving the ignition switch to the **OFF** position. If the engine fails to stop, move the choke lever to the **FULL CHOKE** position to kill the engine. Always check the throttle system to ensure the carburetor throttle lever is returning to the idle position. If the ignition switch should fail, **DO NOT** operate until the ignition switch has been repaired by a qualified mechanic.
- Attach the blade guard to protect blade(s).
- The cutting blades on the ice augers are razor sharp. Use extreme care when handling.
- Use caution when removing or replacing blade guard.
- Use caution when replacing auger blades.
- Always keep the blade guard on auger, except when in use.
- The use of this auger by children is not recommended.

## Customer Service

Continued satisfying performance from your StrikeMaster power ice auger may be assured by applying a minimum amount of preventive maintenance. When it is required the following information is intended to inform you as to where and how you may obtain additional service support.

Contact StrikeMaster Corporation at 763-263-8999 for the service center nearest you. Or, visit our website for assistance in servicing your Strike-Lite II auger: [www.strikemaster.com/servicecenters.html](http://www.strikemaster.com/servicecenters.html)

If for any reason you are in doubt, or have any questions regarding the proper operation, and use of this product, or warranty information please feel free to call during regular business hours or write to: (Sorry - No Collect Calls)

StrikeMaster Corporation  
17217 198th Avenue • Big Lake, Minnesota, USA 55309  
Phone: (763) 263-8999 Fax: (763) 263-8986  
[www.strikemaster.com](http://www.strikemaster.com)

**For engine adjustments, repairs or warranty service contact ROBIN AMERICA SERVICE at 1-630-350-8200 or visit their website [www.robinamerica.com](http://www.robinamerica.com). If you cannot locate a dealer please call one of the following distributors closest to you for assistance: or StrikeMaster at 763-263-8999**

The Bentley Company 4109 Airport Way So. Seattle, WA 98108 800-628-5827	Highway Equipment & Supply 4850 Collins Rd. #103 Orange Park, FL 32073 800-827-3019	Northern Engine and Supply Inc. 2929 W. Superior St. Duluth, MN 55806 218-628-2836	Tri State Engine Service 6125 Valley Dr. Bettendorf, IA 52722 800-289-8676
Capital Engine Co. 97 Cypress St. SW Reynoldsburg, OH 43068 740-964-0089	Highway Equipment & Supply 6015 U.S. Highway 301 N. Tampa, FL 33610 800-827-9092	O'Neill Associates 795 Canning Parkway Victor, NY 14564 800-724-3145	Wilder Motor & Equipment Co. 301 15th Ave. North Nashville, TN 37203 615-329-2365
Central Motive Power 6301 North Broadway Denver, CO 80216 800-822-4332	Kimbers Inc. 115 N Geddes St. Syracuse, NY 13204 800-627-1660	Oscar Wilson Engines & Parts, Inc. 826 Lone Star Drive O'Fallon, MO 63366 800-873-6722	Wilder Motor & Equipment Co. 1219 Rosewood Dr. Columbia, SC 29201 800-922-9564
Central Motive Power 3740 Princeton Dr. NE Albuquerque, NM 87103 800-782-2525	Kimbers Inc. 215 Broad St. Oneida, NY 13421 315-363-4700	Small Engine Clinic 98-019 Kamehameha Hwy. Aiea, HI 96701 808-488-0711	Wilder Motor & Equipment Co. 4649 Astor Rd. Louisville, KY 40218 502-966-5141
Cullum & Brown of Wichita 1607 Wabash Wichita, KS 67214 800-362-3222	King McIver Sales Inc. 6375 Burnt Poplar Rd. Greensboro, NC 27409 800-632-1373	Southeast Service & Supply 1721 "E" Oakbrook Drive Norcross, GA 30093 800-241-4595	Wisconsin Industrial Products 977 Koopman Ln. Elkhorn, WI 53121 800-285-5462
Engine Center 2351 Hilton Rd. Ferndale, MI 48220 800-726-8870	M & L Engine 1212 St. Charles Street Houma, LA 70360 800-960-0068	Southwest Products Corp. 5143 W. Roosevelt Phoenix, AZ 85043 602-269-3581	
FSR 10705 Stoner Dr. Fredricksburg, VA 22408 888-540-9067	Marr Brothers, Inc. 423 East Jefferson Blvd. Dallas, TX 75203 800-627-7276	Southwest Products Corp. 2760 Junipero Ave. Long Beach, CA 90806 562-424-0913	
Highway Equipment & Supply 1016 W. Church St. Orlando, FL 32805 800-827-6495	Northern Engine and Supply Inc. 2710 3rd Avenue North Fargo, ND 58102 800-272-3284	Sullivan Bros., Inc. P.O. Box 461, 139 Robbins Rd. Downingtown, PA 19520 800-222-3636	

# Robin Engines

# OPERATOR'S MANUAL

and MAINTENANCE INSTRUCTIONS for

## Robin Engines

MODEL EH035V

FOUR STROKE ENGINE • AIR COOLED • VERTICAL CRANKSHAFT



THIS SYMBOL POINTS OUT IMPORTANT SAFETY INSTRUCTIONS WHICH IF NOT FOLLOWED COULD ENDANGER THE PERSONAL SAFETY AND/OR PROPERTY OF YOURSELF AND OTHERS. READ AND FOLLOW ALL INSTRUCTIONS IN THIS MANUAL AND ANY PROVIDED WITH THE EQUIPMENT ON WHICH THIS ENGINE IS USED BEFORE ATTEMPTING TO OPERATE YOUR ROBIN ENGINE.



California Proposition 65 **WARNING:** The engine exhaust from this product contains chemicals known to the State of California to cause cancer, birth defects or other reproductive harm.

## GET FAMILIAR WITH ENGINE PARTS

### EH035V

Fuel tank cap  
Fuel upper level  
Fuel tank  
Fill/Drain  
Check Oil Level

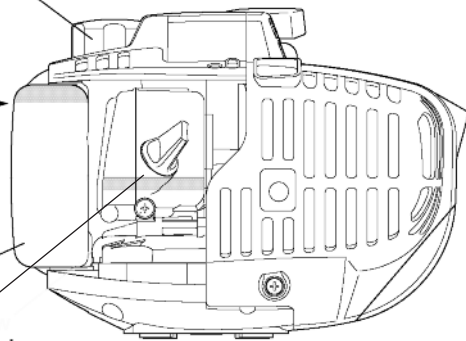

Spark plug  
(Plug cap)

Muffler

Carburetor

Choke lever

Primer pump

Starter  
handle

Air cleaner

Oil gauge  
(Oil filler)

Clutch

Fuel tank

Fuel tank cap

Recoil starter

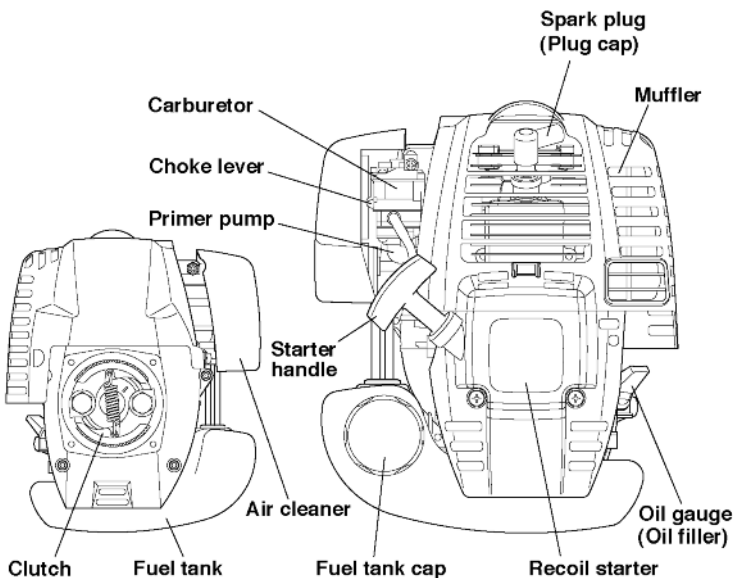

## PRE-OPERATION CHECKS

- 1 CHECK ENGINE OIL**  
Before refilling engine oil, be sure the engine is located on a stable, level surface and not running. Be sure engine is in **operating position when checking oil level.**

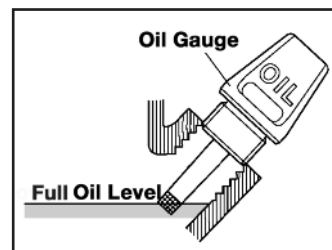

- Do **not** thread the gauge into oil filler neck to check oil level.
- Fill with approximately 1.7 oz. Oil level in operating position must be at lower mark on dipstick.
- Wipe off any spilled oil before starting the engine.



- 2 CHECK FUEL**



### CAUTION



Do not refuel while smoking, near an open flame or other potential hazards.

- Stop the engine and open the cap.
- Incline the engine as fuel inlet upward, then refill fuel to the upper level. Do not overfill.
- Use automotive unleaded gasoline only.
- This engine is a 4-stroke gasoline engine.
- This engine is certified to operate on automotive unleaded gasoline.
- When filling the fuel tank, always use a fuel funnel.
- Wipe off any spilled fuel before starting the engine.

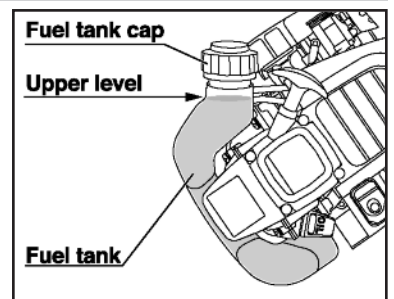

After reading the operating manual, please take time to view the safety/instructional video at [www.strikemaster.com](http://www.strikemaster.com), click on videos tab.

## OPERATING YOUR ENGINE

### 1 STARTING

#### STOP SWITCH

The Stop Switch is located on the throttle lever. Set the Stop Switch to the "on" position before starting. (as pictured)

To stop turn switch to off position.

**Note: Before starting: Be sure to loosen cap slightly to allow any pressure to escape from the tank before attempting to start engine. Be sure to retighten cap so no fuel is spilled.**

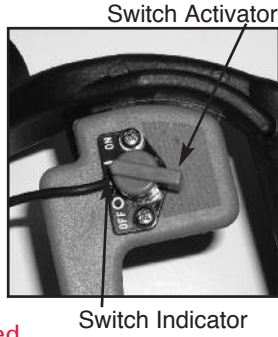

### 2 CHOKE LEVER

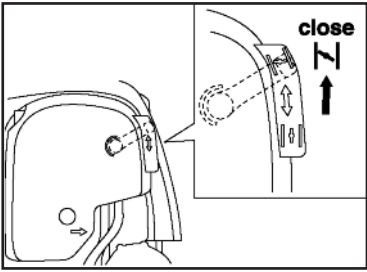

Close the Choke Lever

- If the engine is cold or the ambient temperature is low, close the choke control arm fully.
- If the engine is warm or the ambient temperature is high, open the choke control arm half-way, or keep it fully open.

### 3 PRIMER PUMP

Push the primer pump 7 to 10 times to feed the fuel to the carburetor.

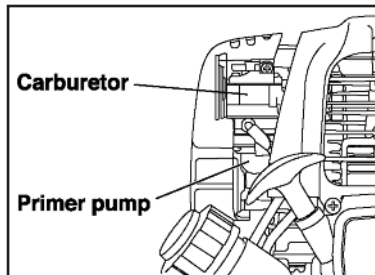

### 4 RECOIL STARTER

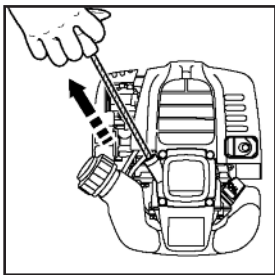

- Pull the starter handle slowly, until resistance is felt. This is the compression point. Return the handle to its original position and pull swiftly.
- Do **not** pull the rope all the way out. **NOTE: In Extremely cold conditions, apply some throttle while pulling recoil rope.**
- After starting the engine, allow the starter handle to return to its original position while still holding the handle.

### 5 CHOKE LEVER

After starting the engine, gradually open choke by turning the lever and finally keep it fully opened.

Do not fully open the choke lever immediately when the engine is cold or the ambient temperature is low, because the engine may stop.

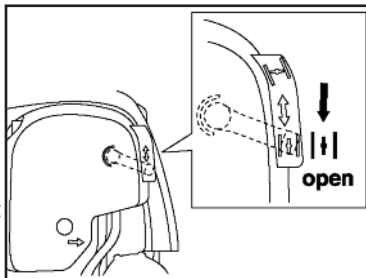

6 If engine fails to start after 5 or 6 pulls. Leave the choke lever on full choke. Lightly feather the throttle as you pull the rope.

## RUNNING

**NOTE: For Best Performance.**

Allow the engine to warm up without load for a few minutes.

Gradually move the throttle lever toward the high speed position.

Note: If the engine is operated upside down, white smoke may be exhausted from the muffler. Do not operate upside down.

## STOPPING

### 1 STOP SWITCH

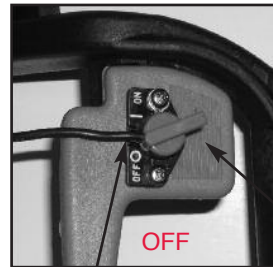

- Set the throttle lever at the low speed position and allow the engine to run at low speed for 2 or 3 minutes before stopping.
- Turn the Stop Switch to the "off" position to stop the motor (as pictured).

### 2 RECOIL STARTER

Pull the starter handle slowly and return handle to its original position when resistance is felt.

- Note: The above operation is necessary to prevent outside moist air from intruding into the combustion chamber.

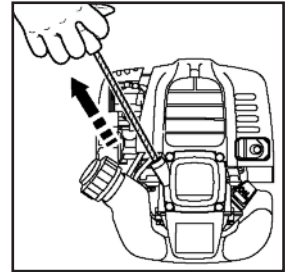

## MAINTENANCE

Regular maintenance is recommended to keep your auger running at top performance.

### INSPECTING THE SPARK PLUG

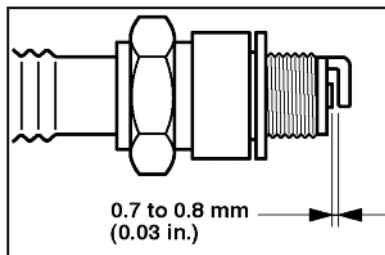

Clean off carbon deposits on the spark plug electrode using a plug cleaner or wire brush.

Check electrode gap. Adjust gap 0.7 mm to 0.8mm (0.03 inches).

Use proper spark plug. NGK CMR6A

## ENGINE OIL CHANGE

Change crankcase oil before the start of every season.

- Initial oil change  
After 20 hours of operation
- Thereafter  
Every 100 hours of operation

- Fill with approximately 1.7 oil. Do Not Over Fill.

- Always use the best grade and clean oil. Contaminated oil, poor quality oil, and the shortage of oil can cause damage to engine or shorten the engine life.

Oil Capacity - EH035V 1.7 oz of 10w30

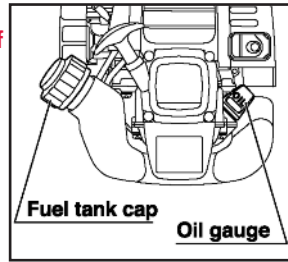

Make sure the fuel cap is tightly secured to avoid gas spillage.

- 1) Remove dip stick and drain oil.

Note: We recommend: StrikeMaster's 4-Stroke Engine 10w30 Oil.

NOTE: The carburetor greatly affects the performance of the engine. Since it has been adjusted carefully at the factory before shipment, avoid adjusting unless absolutely necessary. If adjustments are needed, contact your nearest dealer.

## ADJUSTING CARBURETOR

### Adjusting idling rpm

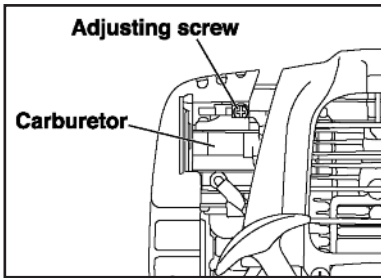

When the adjusting screw is turned right, engine rpm increases, and when it is turned left, rpm decreases. Never have auger rotation at idle.

Normal idling rpm:  
3000±100rpm

## CLEANING AIR CLEANER

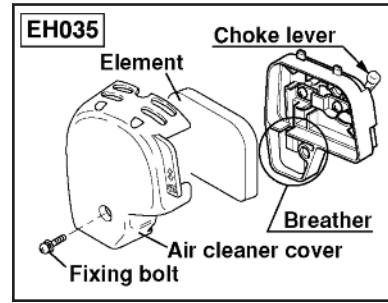

Dirty air cleaner element will cause starting difficulty, power loss, engine malfunctions, and shorten engine life. Keep the air cleaner element clean.

- Remove the fixing bolt of air cleaner cover.
- Pull out the lower edge of the cover to remove the air cleaner cover.
- Place the choke lever to the fully closed position, taking care to ensure that dust and dirt are not allowed to enter the carburetor.

- Remove the element, then clean it with a solution of warm water and mild detergent, thoroughly drying it afterward. Install it in alignment with the lines shown in illustration.

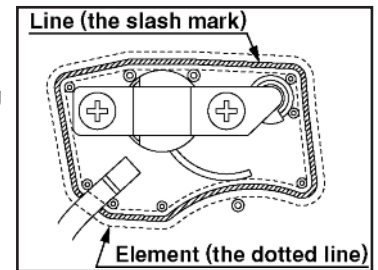

- Wipe off any oil adhering to the area around the air cleaner cover and breather with a cloth.
- After cleaning, reassemble the air cleaner cover insert the tab at left, then insert the right tab and tighten fixing bolt

## CHECKING BOLTS, NUTS AND SCREWS

- Retighten loose bolts and nuts.
- Check for fuel and oil leaks.
- Replace damaged parts with new ones.
- Keep safety in mind.

## FUEL LINE REPLACEMENT

If a fuel leakage is found on the fuel line, replace it immediately.

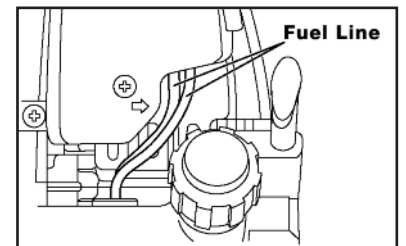

## STORAGE AND REGULAR USE

To prevent hard starting and/or poor engine operation due to deteriorated fuel, use a quality fuel stabilizer.

## SHUT DOWN & STORAGE RECOMMENDATIONS

**Attention! The following are storage recommendations only. Because of today's fuels StrikeMaster cannot guarantee results.**

For stops longer than four weeks the following steps should be carried out:

- Stabilize the fuel; use a quality fuel stabilizer of your choosing
- 1st recommendation: Run the engine every 30 days. Failure to do this can cause carburetor and fuel system problems.
- 2nd recommendation: if you prefer to run the system dry, you **MUST** run stabilized fuel in the system first
- Empty the fuel tank and dispose of properly.
- Start the engine and run until motor stalls.
- Clean the motor well, particularly the air intake openings, cylinder fins and the air filter. Look for signs of corrosive residue from road salts. You can slow this corrosion process using WD-40.
- Spray WD-40 on the blades, screws and any areas showing signs of rust.
- Store all auger styles with blade guard attached.
- Store the equipment in a dry secure place. Open flames or similar must not be nearby. Prevent unauthorized access particularly by children.

### ENGINE OIL

**Change crankcase oil before the start of every season.**

- Change the engine oil with fresh oil.
- Remove the spark plug, pour about 2 cc (about 4 drops) engine oil into the cylinder, slowly pull the starter handle of the recoil starter 2 or 3 times, and tighten the spark plug.

### CLEAN AND STORE

- Slowly pull the recoil starter handle until resistance is felt, and leave it in that position.
- Clean the engine thoroughly with a clean cloth, put the cover on and store the engine indoors in well ventilated, low humidity area.



## WARNING

The engine exhaust from this product contains chemicals known to the State of California to cause cancer, birth defects or other reproductive harm.

### NOTICE

FEDERAL EMISSION COMPONENT DEFECT WARRANTY and CALIFORNIA EMISSION CONTROL WARRANTY are applicable to only those engines complied with EPS (Environmental Protection Agency) and CARD (California Air Resources Board) emission regulations in the U.S.A.

### NOTICE

To the engines exported to and used in the countries other than the U.S.A., warranty service shall be performed by the distributor in each country in accordance with the standard Robin engine warranty policy as applicable.

### AIR INDEX

To show compliance with California emission regulations, a hangtag has been provided displaying the Air Index level and durability period of this engine.

The Air Index level defines how clean an engine's exhaust is over a period of time. A bar graph scaled from "0" (most clean) to "10" (least clean) is used to show an engine's Air Index level. A lower Air Index level represents cleaner air.

The period of time (in hours) that the Air Index level is measured is known as the durability period. Depending on the size of the engine, a selection of time periods can be used to measure the Air Index level (see below).

Descriptive Term	Applicable to Emissions Durability Period
Moderate -	50 hours (engine from 0 to 80 cc) 125 hours (engine greater than 80 cc)
Intermediate -	125 hours (engine from 0 to 80 cc) 250 hours (engine greater than 80 cc)
Extended -	300 hours (engine from 0 to 80 cc) 500 hours (engine greater than 80 cc)

Notice : This hangtag must remain on this engine or piece of equipment, and only be removed by the ultimate purchaser before operation.

## PROPER POSITION WHEN LAYING THE STRIKE-LITE II AUGER DOWN WHEN NOT IN USE

Throttle side of handle down otherwise muffler or carburetor side are recommended.





## FEDERAL EMISSIONS COMPONENT DEFECT WARRANTY

**EMISSIONS COMPONENT DEFECT WARRANTY COVERAGE** - This emission warranty is applicable in all States, except the State of California Fuji Heavy Industries Lt. and Robin America Inc., Wood Dale Illinois, (herein "ROBIN AMERICA") warrant(s) to the initial retail purchaser and each subsequent owner, that this Nonroad engine (herein "engine") has been designed, built, and equipped to conform at the time of initial sale to all applicable regulations of the U.S. Environmental Protection Agency (EPA), and that the engine is free of defects in materials and workmanship which would cause this engine to fail to conform with EPA regulations during its warranty period. For the components listed under PARTS COVERED, the service dealer authorized by ROBIN AMERICA will, at no cost to you, make the necessary diagnosis, repair, or replacement necessary to ensure that the engine complies with applicable U.S. EPA regulations.

### EMISSION COMPONENT DEFECT WARRANTY PERIOD

The warranty period for this engine begins on the date of sale to the initial purchaser and continues for a period of 1 year.

### PARTS COVERED

Listed below are the parts covered by the Emission Components Defect Warranty. Some of the parts listed below may require scheduled maintenance and are warranted up to the first scheduled replacement point for that part.

#### (1) Fuel Metering System

- (i) Carburetor and internal parts (and/or pressure regulator or fuel injection system).
- (ii) Air/fuel ratio feedback and control system, if applicable.
- (iii) Cold start enrichment system, if applicable.
- (iv) Regulator assy (gaseous fuel, if applicable)

#### (2) Air Induction System

- (i) Intake manifold, if applicable
- (ii) Air filter.

#### 3) Ignition System

- (i) Spark plugs.
- (ii) Magneto or electronic ignition system.
- (iii) Spark advance/retard system, if applicable.

#### 4) Exhaust manifold, if applicable

#### 5) Miscellaneous Items Used in Above Systems

- (i) Electronic controls, if applicable
- (ii) Hoses, belts, connectors, and assemblies.
- (iii) Filter lock assy (gaseous fuel, if applicable)

### OBTAINING WARRANTY SERVICE

To obtain warranty service, take your engine to the nearest authorized Robin America service dealer. Bring your sales receipts indicating date of purchase for this engine. The service dealer authorized by ROBIN AMERICA will perform the necessary repairs or adjustments within a reasonable amount of time and furnish you with a copy of the repair order. All parts and accessories replaced under this warranty become the property of ROBIN AMERICA.

### WHAT IS NOT COVERED

\*Conditions resulting from tampering, misuse, improper adjustment (unless they were made by the service dealer authorized by ROBIN AMERICA during a warranty repair), alteration, accident, failure to use the recommended fuel and oil, or not performing required maintenance services.

\*The replacement parts used for required maintenance services.

\*Consequential damages such as loss of time, inconvenience, loss of use of the engine or equipment, etc.

\*Diagnosis and inspection charges that do not result in warranty-eligible service being performed.

\*Any non-authorized replacement part, or malfunction of authorized parts due to use of non-authorized parts.

### OWNER'S WARRANTY RESPONSIBILITIES

As the engine owner, you are responsible for the performance of the required maintenance listed in your owner's manual. ROBIN AMERICA recommends that you retain all receipts covering maintenance on your engine, but ROBIN AMERICA cannot deny warranty solely for the lack of receipts or for your failure to ensure the performance of all scheduled maintenance.

As the engine owner, you should however be aware that ROBIN AMERICA may deny warranty coverage if your engine or a part has failed due to abuse, neglect, improper maintenance or unapproved modifications.

You are responsible for presenting your engine to the nearest service dealer authorized by ROBIN AMERICA when a problem exists.

If you have any questions regarding your warranty rights and responsibilities, you should contact the Robin America customer service department at 1-630-350-8200 for the information.

### THINGS YOU SHOULD KNOW ABOUT THE EMISSION CONTROL SYSTEM WARRANTY

#### MAINTENANCE AND REPAIRS

You are responsible for the proper maintenance of the engine. You should keep all receipts and maintenance records covering the performance of regular maintenance in the event questions arise. These receipts and maintenance records should be transferred to each subsequent owner of the engine. ROBIN AMERICA reserves the right to deny warranty coverage if the engine has not been properly maintained. Warranty claims will not be denied, however, solely because of the lack of required maintenance or failure to keep maintenance records.

MAINTENANCE, REPLACEMENT OR REPAIR OF EMISSION CONTROL DEVICES AND SYSTEMS MAY BE PERFORMED BY ANY REPAIR ESTABLISHMENT OR INDIVIDUAL; HOWEVER, WARRANTY REPAIRS MUST BE PERFORMED BY A SERVICE DEALER AUTHORIZED BY ROBIN AMERICA. THE USE OF PARTS THAT ARE NOT EQUIVALENT IN PERFORMANCE AND DURABILITY TO AUTHORIZED PARTS MAY IMPAIR THE EFFECTIVENESS OF THE EMISSION CONTROL SYSTEM AND MAY HAVE A BEARING ON THE OUTCOME OF A WARRANTY CLAIM.

If other than the parts authorized by ROBIN AMERICA are used for maintenance replacements or for the repair of components affecting emission control, you should assure yourself that such parts are warranted by their manufacturer to be equivalent to the parts authorized by ROBIN AMERICA in their performance and durability.

#### HOW TO MAKE A CLAIM

All repair qualifying under this limited warranty must be performed by a service dealer authorized by ROBIN AMERICA. In the event that any emission-related part is found to be defective during the warranty period, you shall notify Robin America customer service department at 1-630-350-8200 and you will be advised of the appropriate warranty service dealer or service providers where the warranty repair can be performed.

### CALIFORNIA EMISSION CONTROL WARRANTY YOUR WARRANTY RIGHTS AND OBLIGATIONS

The California Air Resources Board and Fuji Heavy Industries Lt. (herein "FUJI") are pleased to explain the emission control system warranty on your 2005 and later Small Off-Road engine (herein "engine"). In California, new engine must be designed, built and equipped to meet the State's stringent anti-smog standards. FUJI must warrant the emission control system on your engine for the periods of time described below, provided there has been no abuse, neglect or improper maintenance of your engine. Your emission control system may include parts such as the carburetor or fuel-injection system, and the ignition system. Also included may be hoses, belts, connectors and other emission-related assemblies. Where a warrantable condition exists, FUJI will repair your engine at no cost to you including diagnosis, parts and labor.

#### MANUFACTURER'S WARRANTY COVERAGE :

The 2005 and later engines are warranted for one (1) years. If any emission related part on your engine is defective, the part will be repaired or replaced by FUJI.

#### OWNER'S WARRANTY RESPONSIBILITIES :

-As the engine owner, you are responsible for the performance of the required maintenance listed in your Owner's Manual. FUJI recommends that you retain all receipts covering maintenance on your engine, but FUJI cannot deny warranty solely for the lack of receipts or for your failure to ensure the performance of all scheduled maintenance.

-As the engine owner, you should ,however, be aware that FUJI may deny you warranty coverage if your engine or a part has failed due to abuse, neglect, improper maintenance or unapproved modifications.

-You are responsible for presenting your engine to a service dealer or warranty station authorized by ROBIN AMERICA Inc. 940 Lively Blvd., Wood Dale, IL 60191 (herein ROBIN AMERICA) as soon as a problem exists. The warranty repairs should be completed in a reasonable amount of time, not to exceed 30 days.

If you have any questions regarding your warranty rights and responsibilities, you should contact the Robin America Inc. Customer Service Department at 1-630-350-8200

**LIMITED WARRANTY on Emission Control Systems - California Only -**

FUJI warrants to the owner of the 2005 and later engine that the engine (1)has been designed, built and equipped so as to conform at the time of manufacture with the applicable regulations of the California Air Resources Board, and (2) is free from defects in materials and workmanship that could cause it to fail to conform with those regulations as may be applicable in the terms and conditions stated below.

**A. COMMENCEMENT DATE**

The warranty period begins on the date the engine is delivered to a first retail purchaser.

**B. LENGTH OF COVERAGE**

FUJI warrants to a first retail purchaser and each subsequent purchaser that the engine is free from defects in materials and workmanship that cause the failure of a warranted emission related part for a period of one (1) year after the date of delivery to the first retail purchaser.

**C. WHAT IS COVERED :**

**1. REPAIR OR REPLACEMENT PARTS**

Repairs and replacement of any warranted part will be performed at no charge to you by an authorized service dealer or a warranty station. You may contact the Robin America Inc. Customer Service Department at 1-630-350-8200 to obtain the name of the nearest appropriate location where your warranty repairs are performed.

**2. WARRANTY PERIOD**

This warranty continues for a period of one (1) year and applies only to the repair, replacement or adjustment of the component parts that are not scheduled for replacement as required maintenance. Further, component parts which are scheduled only for regular inspection to the effect of "repair or replace as necessary" are warranted for the warranty period. Any warranted part which is scheduled for replacement as required maintenance is warranted for the period of time up to the first scheduled replacement point for that part.

**3. DIAGNOSIS**

You will not be charged for diagnostic labor that leads to the determination that a warranted part is defective, if the diagnostic work is performed at an authorized service dealer or warranty station.

**4. DAMAGES**

If a warranted part failed causing damage to other engine components, consult a warranty station.

**D. WHAT IS NOT COVERED**

1. This limited warranty does not cover any part which malfunctions, fails or is damaged due to failure to follow the maintenance and operating instructions set forth in the 2005 and later Owner's Manual including:

- (1) improper maintenance of any warranted parts
- (2) improper installation, adjustment or repair of the engine or of any warranted part unless performed by an authorized service dealer
- (3) failure to follow recommendations on fuel use contained in the 2005 and later Owner's Manual
- (4) repairs performed outside of the authorized warranty service dealers
- (5) use of parts which are not authorized by FUJI

**2. Add-on or modified parts**

This warranty does not cover any part that malfunctions, fails or is damaged due to alterations by changing, adding to or removing parts from the engine.

**3. Expenses incurred by processing warranty claims**

FUJI, any authorized service dealer and warranty station shall not be liable for any loss of use of the engine, for any alternative usage, for any damage to goods, loss of time or inconvenience.

**E. HOW TO FILE A CLAIM**

All repairs qualifying under this Limited Warranty must be performed by a dealer who sold you the engine or warranty station authorized by ROBIN. In the event that any emission related part is found to be defective during the warranty period, you must notify the Robin America Inc. Customer Service Department at 1-630-350-8200 and you will be advised of the appropriate warranty service facilities where the warranty repair is to be performed.

**F. WHERE TO OBTAIN WARRANTY SERVICE**

It is recommended that warranty service be performed by the authorized dealer who sold you the engine, although warranty service will be performed by any authorized service dealers or warranty stations anywhere in the United States. When warranty repair is needed, the engine must be brought to an authorized service dealer or warranty station's place of business during normal business hours. In all cases, a reasonable time, not to exceed 30 days, must be allowed for the warranty repair to be completed after the engine is received by the authorized service dealer or warranty station.

**G. MAINTENANCE, REPLACEMENT AND REPAIR OF EMISSION-RELATED PARTS**

Only warranted engine replacement parts approved by FUJI should be used in the performance of any warranty maintenance or repairs on emission-related parts. If other than authorized parts are used for maintenance, replacement or repair of components affecting emission control, you should assure yourself that such parts are warranted by their manufacturer to be equivalent to authorized parts in performance and durability. FUJI, however, assumes no liability under this warranty with respect to parts other than authorized parts. The use of non-authorized replacement parts does not invalidate the warranty on other components unless the nonauthorized parts cause damage to warranted parts.

**H. PARTS COVERED UNDER THE CALIFORNIA EMISSIONS WARRANTY**

- (1) Fuel Metering System
  - (i) Carburetor and internal parts (and/or pressure regulator or fuel injection system).
  - (ii) Air/fuel ratio feedback and control system, if applicable.
  - (iii) Cold start enrichment system, if applicable.
  - (iv) Regulator assy (gaseous fuel, if applicable)
- (2) Air Induction System
  - (i) Intake manifold, if applicable
  - (ii) Air filter.
  - (3) Ignition System
    - (i) Spark plugs.
    - (ii) Magneto or electronic ignition system.
    - (iii) Spark advance/retard system, if applicable.
  - (4) Exhaust manifold, if applicable ENGLISH (US)
  - (5) Miscellaneous Items Used in Above Systems
    - (i) Electronic controls, if applicable
    - (ii) Hoses, belts, connectors, and assemblies.
    - (iii) Filter lock assy (gaseous fuel, if applicable)

**I. MAINTENANCE STATEMENTS**

It is your responsibility to have all scheduled inspection and maintenance services performed at the times recommended in the 2005 and later Owner's Manual and to retain proof that inspection and maintenance services are performed at the times when recommended. FUJI will not deny a warranty claim solely because you have no record of maintenance; however, FUJI may deny a warranty claim if your failure to perform required maintenance resulted in the failure of warranted part. The proof which you maintain should be given to each subsequent owner of the engine. You are responsible for performing the scheduled maintenance described below based on the procedures specified in the 2005 and later Owner's Manual. The scheduled maintenance below is based on a normal engine operating schedule.

**PROCEDURE INTERVAL**

- 1) Change engine oil : Initial 20 hours and every 100 hours afterward
- 2) Clean air cleaner (element) : Every 50 hours
- 3) Replace air cleaner element : Every 200 hours
- 4) Clean and adjust spark plug and electrodes : Every 200 hours

Note : More frequent maintenance may be necessary under dusty, dirty or severe conditions.

# StrikeMaster Ice Augers

## LIMITED WARRANTY

StrikeMaster Corporation, 17217 198th Avenue, Big Lake, Minnesota 55309 provides the following LIMITED WARRANTY on its products to the purchaser of these products and to any person to whom such products are transferred during the duration of this warranty.

The warrantor's obligation shall be limited to repairing or replacing at the above address, any part or parts which shall within a One Year period hereinafter specified to be returned to them with transportation prepaid (**customer is responsible for shipping charges to StrikeMaster**) and which upon examination by **StrikeMaster Corporation** shows to have been defective (**proof of purchase required**). This warranty shall NOT APPLY IF:

- A. The product has been altered, repaired or modified outside the warrantor's place of business in any way that would adversely affect its operation.
- B. The product has been subjected to misuse or damage while in the possession of the purchaser or was operated or used other than in accordance with the manufacturer's operating instructions.
- C. The product failure is attributed to damage which is the sole responsibility of the user.

The One Year limited warranty period shall commence with the date the product is sold to the purchaser by the dealer, or if this date cannot be established, the date the product was sold by **StrikeMaster Corporation** to the distributor or dealer.

THE IMPLIED WARRANTIES OF MERCHANTABILITY AND FITNESS FOR PARTICULAR PURPOSES ARE LIMITED TO THE DURATION OF THIS WARRANTY — One Year — AFTER SAID One Year **StrikeMaster Corporation** EXPRESSLY DISCLAIMS ANY WARRANTY OR MERCHANTABILITY OR FITNESS FOR ANY PARTICULAR PURPOSE.

Purchase or other acceptance of the product by the claimant shall be on the condition and agreement that **StrikeMaster Corporation** SHALL NOT BE LIABLE FOR INCIDENTAL OR CONSEQUENTIAL DAMAGES OF ANY KIND.

Some states do not allow limitations on how long an implied warranty lasts or do not allow the exclusion or limitations of incidental or consequential damages, so the above limitation or exclusions may not apply to you.

To make claim under this warranty, write or call (763) 263-8999 directly to "**CUSTOMER SERVICE**", **StrikeMaster Corporation** at the above address for a warranty return authorization. **StrikeMaster Corporation** will make every effort to repair or replace the product if found to be defective within the terms of this warranty within 30 days after receipt of the product.

**Proof-of-Purchase must accompany product to ensure warrantability.**

**NOTE:** This warranty gives you specific legal rights, and you may also have other rights which vary from State to State.

### Warranty Registration

This registration card must be returned to StrikeMaster Corporation to validate the One Year Limited Warranty. Register online at [www.strikemaster.com/warranty.html](http://www.strikemaster.com/warranty.html)

NAME \_\_\_\_\_ DATE PURCHASED \_\_\_\_\_

ADDRESS \_\_\_\_\_

CITY \_\_\_\_\_ STATE \_\_\_\_\_ ZIP \_\_\_\_\_

SERIAL # \_\_\_\_\_

PRODUCT PURCHASED	SIZE	PRODUCT PURCHASED	SIZE
<input type="checkbox"/> MORA Hand Auger	_____	<input type="checkbox"/> Lazer Pro	_____
<input type="checkbox"/> Lazer Hand Auger	_____	<input type="checkbox"/> Electra Lazer 12000 DP	_____
<input type="checkbox"/> Lazer Mag	_____	<input type="checkbox"/> Big Volt Electric	_____
<input type="checkbox"/> Magnum	_____	<input type="checkbox"/> Strike-Lite II	_____

PURCHASER:  Male  Female

AGE: \_\_\_\_\_

PURCHASED AS A:  Gift  Own Use

PURCHASED AT:  Local Dealer  On-Line

Catalog  Chain Store

Would you like future new product releases and information from StrikeMaster sent to your email?

Yes / No Email address \_\_\_\_\_

SM 11

763-263-8999  
[www.strikemaster.com](http://www.strikemaster.com)  
Fax: 763-263-8986

## SEE SPECIAL BROCHURE

- Replacement Blades
- Blade Exchange Service
- Blade Guards
- Auger Extensions
- Gift Ideas



**For Information on our Tune-Up Service, please visit our website at  
[www.strikemaster.com](http://www.strikemaster.com)  
or call 763-263-8999**

PLACE  
STAMP  
HERE

**StrikeMaster Corporation**  
17217 198th Avenue  
Big Lake, Minnesota 55309